

W100T Twin Alternating Series Softeners

Installation, Operation and Maintenance Manual



W100T Twin Alternating Softener

⚠ WARNING



Read this Manual BEFORE using this equipment.
Failure to read and follow all safety and use information can result in death, serious personal injury, property damage, or damage to the equipment.
Keep this Manual for future reference.



⚠ WARNING

You are required to consult the local building and plumbing codes prior to installation. If the information in this manual is not consistent with local building or plumbing codes, the local codes should be followed. Inquire with governing authorities for additional local requirements.

⚠ WARNING

Need for Periodic Inspection/Maintenance: This product must be tested periodically in compliance with local codes, but at least once per year or more as service conditions warrant. All products must be retested once maintenance has been performed. Corrosive water conditions, and/or unauthorized adjustments or repair could render the product ineffective for the service intended. Regular checking and cleaning of the product's internal components helps assure maximum life and proper product function.

NOTICE

HYDROCARBONS SUCH AS KEROSENE, BENZENE, GASOLINE, ETC., MAY DAMAGE PRODUCTS THAT CONTAIN O-RINGS OR PLASTIC COMPONENTS. EXPOSURE TO SUCH HYDROCARBONS MAY CAUSE THE PRODUCTS TO LEAK. DO NOT USE THE PRODUCT(S) CONTAINED IN THIS DOCUMENT ON WATER SUPPLIES THAT CONTAIN HYDROCARBONS SUCH AS KEROSENE, BENZENE, GASOLINE, ETC.

Table of Contents

System Specification Table	2
Safety Information	3
General Warnings	3
Pre-Installation Considerations	5
General Installation Instructions	5
W100T System Programming	6
W100T Quick Programming Guide	6
Regeneration and Error Screens	7
Button Operation and Function	7
Regeneration Cycles and Times	7
User Displays	8
Configuration Settings	9-12
OEM Softener System Setup	13-15
Option Table	16
OEM Filter System Setup	17-18
Installer Display Settings	19
Diagnostics	20-21
W100T Part List and Drawings	22
Front Cover and Drive Assembly	22
Valve Body Compliance Table	23
W100T with 1.050" Distributor Tube Opening Identification	23
Drive Cap Assembly, Downflow Piston, Upflow Piston, Regenerant Piston and Spacer Stack Assembly	24
Twin Transfer	25-26
Injector Cap, Injector Screen, Injector, Plug and O-Ring	27
Injector Order Information	28
Refill Flow Control Assembly and Refill Port Plug	33
Drain Line - 3/4"	34
Drain Line - 1"	35
V4017-01 T1 Interconnect Fitting Assembly	36
D1400 1191 In/Out Head	37
W100T Control Valve System Description	38
Drive Assembly	38
Drive Cap Assembly, Main Piston and Regenerant Piston	38
Spacer Stack Assembly	39
Injector Cap, Screen, Injector Plug and Injector	39
Refill Flow Control Assembly or Refill Port Plug	39
Drain Line Flow Control and Fitting Assembly	40
Service Instructions	41
Drive Assembly	41
Drive Cap Assembly, Main Piston and Regenerant Piston	42
Spacer Stack Assembly	43
Injector Cap, Screen, Injector Plug and Injector	43
Refill Flow Control Assembly or Refill Port Plug	43
Water Meter	44
Servicing Transfer Cap Assemblies	45-46
Troubleshooting	47-50
NOTES	51

System Specification Table

A. Models Chart

MODEL NO.	CAPACITY (MAX.)	PIPE SIZE (IN.)	MINERAL TANK			BRINE TANK		FLOW RATE & PRESSURE			SHIP WT. (LBS.)
			TANK SIZE	RESIN FT ³	GRAVEL (LBS.)	TANK SIZE	SALT FILL	SERVICE (GPM)	DROP (PSI)	BKW (GPM)	
M2058-W100T	30,000	1	9 x 48	1	15	18 x 40	400	13-19	15-25	2.2	230
M2059-W100T	45,000	1	10 x 54	1.5	20	18 x 40	400	14-21	15-25	2.7	290
M2060-W100T	60,000	1	12 x 52	2	30	18 x 40	400	15-21	15-25	2.7	420
M2063-W100T	75,000	1	13 x 54	2.5	45	18 x 40	400	15-21	15-25	4.2	460
M2066-W100T	90,000	1	14 x 65	3	60	18 x 40	400	17-22	15-25	5.3	500
M2069-W100T	120,000	1	16 x 65	4	80	18 x 40	400	17-24	15-25	7.5	650
M2070-W100T	150,000	1.25" x 1.5"	18 x 65	5	100	24 x 41	600	18-25	15-25	10	890
M2072-W100T	210,000	1.25" x 1.5"	21 x 62	7	100	24 x 50	800	20-27	15-25	12	1160

Safety Information

This water conditioner's control valve conforms to UL/CE Standards. Generic valves were tested and certified for compliance as verified by the agency listing.

- Please review the entire Installation and Operation Manual before installing the water conditioning system.
- As with all plumbing projects, it is recommended that a trained professional water treatment dealer install the water conditioning system. Please follow all local plumbing codes for installing this water conditioning system.
- This system will not make microbiologically unsafe water safe. Water that is unsafe must be treated separately from this conditioner.
- This water conditioning system is to be used only for potable water.
- Inspect the water conditioning system for carrier shortage or shipping damage before beginning installation.
- Use only lead-free solder and flux, as required by federal and state codes, when installing soldered copper plumbing.
- Use caution when installing soldered metal piping near the water conditioning system. Heat can adversely affect the plastic control valve and bypass valve.
- All plastic connections should be hand tightened. Teflon® tape may be used on connections that do not use an O-ring seal. Do not use pipe dope type sealants on the valve body. **Do not use pliers or pipe wrenches.**
- Use only the power transformer supplied with this water conditioning system.
- All electrical connections must be completed according to local codes.
- The power outlet must be grounded.
- Install an appropriate grounding strap across the inlet and outlet piping of the water conditioning system to ensure that a proper ground is maintained.
- To disconnect power, unplug the AC adapter from its power source.
- Observe drain line requirements.
- **Operating ambient temperature: 40° to 110°F (5° to 43°C).**
- **Operating water temperature: 40° to 110°F (5° to 43°C).**
- **Operating water pressure range : 25 to 120 psi (1.7 to 8.27bar).**
- Keep the media tank in the upright position. Do not turn upside down or drop. Turning the tank upside down or laying the tank on its side can cause media to enter the valve.
- Use only regenerants designed for water conditioning. Do not use ice melting salt, block salt or rock salt. During cold weather it is recommended that the installer warm the valve to room temperature before operating. Teflon® is a trademark of E.I. duPont de Nemours.
- Do not use petroleum-based lubricants such as Vaseline, oils or hydrocarbon-based lubricants. Use only 100% silicone lubricants.
- Do not support the weight of the system on the control valve fittings, plumbing, or the bypass.
- Do not allow this water conditioning system to freeze. Damage from freezing will void this water conditioning system's warranty.

▲ WARNING

General Warnings

- The control valve, fittings and/or bypass are designed to accommodate minor plumbing misalignments but are not designed to support the weight of a system or the plumbing.
- **HYDROCARBONS SUCH AS KEROSENE, BENZENE, GASOLINE, ETC., MAY DAMAGE PRODUCTS THAT CONTAIN O-RINGS OR PLASTIC COMPONENTS. EXPOSURE TO SUCH HYDROCARBONS MAY CAUSE THE PRODUCTS TO LEAK. DO NOT USE THE PRODUCT(S) CONTAINED IN THIS DOCUMENT ON WATER SUPPLIES THAT CONTAIN HYDROCARBONS SUCH AS KEROSENE, BENZENE, GASOLINE, ETC.**
- **THIS WATER METER SHOULD NOT BE USED AS THE PRIMARY MONITORING DEVICE FOR CRITICAL OR HEALTH EFFECT APPLICATIONS.**
- Do not use Vaseline, oils, other hydrocarbon lubricants or spray silicone anywhere. A silicone lubricant may be used on black o-rings but is not necessary.
- The nuts and caps are designed to be unscrewed or tightened by hand or with the special plastic wrench. If necessary a pliers can be used to unscrew the nut or cap. Do not use a pipe wrench to tighten or loosen nuts or caps. Do not place a screwdriver in the slots on caps and/or tap with a hammer.
- Do not use pipe dope or other sealants on threads. Use Teflon tape on the threaded inlet, outlet and drain fittings. Teflon tape is not necessary on the nut connection or caps because of o-ring seals.
- After completing any valve maintenance involving the drive assembly or the drive cap assembly and pistons unplug power source jack from the printed circuit board (black wire) and plug back in or press and hold NEXT and REGEN buttons for 3 seconds. This resets the electronics and establishes the service piston position. The display should flash all wording, then flash the software version and then reset the valve to the service position.
- All plumbing should be done in accordance with local plumbing codes. The pipe size for the drain line should be a minimum of 1/2". Backwash flow rates in excess of 7 gpm (26.5 lpm) or length in excess of 20' (6.1m) require 3/4" drain line.
- Solder joints near the drain must be done prior to connecting the drain line flow control fitting. Leave at least 6" between the drain line control fitting and solder joints when soldering pipes that are connected on the drain line control fitting. Failure to do this could cause interior damage to the drain line flow control fitting.
- When assembling the installation fitting package (inlet and outlet), connect the fitting to the plumbing system first and then attach the nut, split ring and o-ring. Heat from soldering or solvent cements may damage the nut, split ring or o-ring. Solder joints should be cool and solvent cements should be set before installing the nut, split ring and o-ring. Avoid getting primer and solvent cement on any part of the o-rings, split rings, bypass valve or control valve.
All electrical connections must be connected according to local codes. (Be certain the outlet is uninterrupted.)
- Install grounding strap on metal pipes.

▲ WARNING

General Warnings (continued)

- This glass filled Noryl¹ (or equivalent) fully automatic control valve is designed as the primary control center to direct and regulate all cycles of a water softener or filter.
- The control valve is compatible with a variety of regenerants and resin cleaners. The control valve is capable of routing the flow of water in the necessary paths to regenerate or backwash water treatment systems. The injector regulates the flow of brine or other regenerants. The control valve regulates the flow rates for backwashing, rinsing, and the replenishing of treated water into a regenerant tank, when applicable.
- Control valve installation is made easy because the distributor tube can be cut ½" above to ½" below the top of tank thread. The distributor tube is held in place by an o-ring seal and the control valve also has a bayonet lock feature for upper distributor baskets.
- The power adapter comes with a 15 foot power cord and is designed for use with the control valve. The power adapter is for dry location use only. The control valve remembers all settings until the battery power is depleted if the power goes out.
- After the battery power is depleted, the only item that needs to be reset is the time of day; other values are permanently stored in the nonvolatile memory. The control valve battery is not rechargeable but is replaceable.
- No user serviceable parts are on the PC board, the motor or the power adapter. The means of disconnection from the main power supply is by unplugging the power adapter from the wall.

Pre-Installation Considerations

A. Water Pressure

A minimum of 25 pounds of water pressure is required for regeneration valve to operate effectively.

B. Electrical Facilities

A continuous 115 volt, 60 Hertz current supply is required. Make certain the current supply is always hot and cannot be turned off with another switch.

C. Existing Plumbing

Condition of existing plumbing should be free from lime and iron buildup. Piping that is built up heavily with lime and/or iron should be replaced. If piping is clogged with iron, a separate iron filter unit should be installed ahead of the water softener.

D. Location Of Softener And Drain

The softener should be located close to a drain.

E. Bypass Valves

Always provide for the installation of a bypass valve.

F. Valve to Tank Installation Instructions

1. Spin the valve onto the tank, ensuring the threads are not cross-threaded.

NOTICE

The main control valve and tank adaptor have right-hand threads, or clockwise, to install

2. Rotate the valve freely without using force until it comes to a stop (this position is considered zero).
3. Rotate the valve clockwise from zero, between ¼ turn and ½ turn to fully tighten. No tools are needed. Hand tight is enough. Overtightening may cause valve or tank damage.

NOTICE

If lubricant is required, a silicone compound is strongly recommended. Dow Corning® Silicone Compound (available from Watts), is recommended for best possible results. Dow Corning® 7 Release Compound is used in the manufacture of this control valve. The use of other types of lubricants may attack the control's plastic or rubber components. Petroleum-based lubricants can cause swelling in rubber parts, including O-rings and seals.

¹Noryl is a trademark of Sabic.

Pre-Installation Considerations (continued)

G. Pre Installation and Loading of Media

Systems that are 13" in diameter and larger are not loaded with media. These systems must be loaded with media before placing into service. To load a system follow the below steps.

1. Cap the top open end of the distributor tube with tape and plastic sheeting to keep foreign debris from entering the distributor tube. This cap must be secure and not come off during media loading.
2. Place the distributor tube, screen end down, into the mineral tank and center it in the bottom. The top of the distributor tube should be flush with the top of the tank. If 4" x 2.5" tank bushings are used, the distributor tube should be flush with the top of the tank bushing.
3. Make sure the plastic and tape cap is secure to the top of the distributor tube, place a funnel on the top of the tank and load first the gravel (if different sizes of gravel are used load the largest gravel first, then the smaller gravel) then the resin media into the tank. The cap must not come off of the distributor tube during the loading of the media.
4. Remove the plastic cap from the distributor tube. **DO NOT PULL UP ON THE DISTRIBUTOR TUBE** when removing the cap. The distributor tube top must remain flush with the top of the tank.
5. Clean any media from the threads and top of the mineral tank.
6. Lubricate the O-rings on the bottom of the control valve (distributor pilot O-ring and top of tank O-ring). Use non-petroleum based silicone lubricant only.
7. Place the control valve on top of the tank. When doing this step, seat the top of the distributor tube inside the centered O-ring sealed port on the bottom of the valve first then press the valve down until the tank threads come in contact with the valve threads. This ensures that the distributor tube is properly seated into the bottom of the control valve. Thread the valve on to the tank clockwise. Be careful not to cross thread the valve or over tighten it. A hand tight snug fit is appropriate for the control valve torque. A wrench is not necessary. Do not use thread sealant or PTFE tape on the valve base threads.
8. The system is now ready for installation. Follow the Installation Section in the Installation, Operation and Maintenance Manual.

⚠ WARNING

Do not exceed water pressure of 120 psi (8.2 bar). Do not exceed 110°F (43.3°C). Do not subject unit to freezing conditions.

General Installation Instructions

1. Turn off water heater(s).
2. Turn off the main water supply to the home and open an inside faucet (cold and hot) to relieve any pressure within the plumbing system.
3. Place the system in the desired installation location. Make sure that the location is level and sturdy enough to support the weight of the system once it is in operation.
4. Place the bypass valve in the bypass position.
5. Connect the cold water supply to the inlet of the water conditioning system. While constructing the supply line, install a master supply valve (user supplied) in the supply line and close it.
6. Connect the feed water line to the home to the outlet of the system.
7. Plumb the drain line to an appropriate drain abiding by all local, city, and state codes. Use a 3/4" drain line for backwash flow rates of 7 gpm or for drain lines of 7 gpm and less that exceed 20' in length. Use a 1" drain line for backwash flow rates of 10 gpm and 12 gpm.
8. Connect the brine tank to the water softener control valve brine inlet port using the factory supplied fittings and tubing. Add enough water to the brine tank so that water covers the top of the air check. **DO NOT ADD SALT AT THIS TIME.**
9. Open the user supplied feed water valve. Check for leaks and repair as needed.
10. Allow the inside hot and cold faucet to remain open until all air has been purged from the plumbing system. Then close the faucet.
11. Locate Manual Regeneration Options in this manual to see the steps to initiate an Immediate Manual Regeneration. Once you have read that section place the system in backwash and unplug the system from its electrical outlet once it has cycled into the backwash position. This will stall the unit in backwash so all air can be purged from one of the tanks.
12. Adjust the user supplied feed water valve to 1/4 open and place the bypass valve into the service position.
13. Air will come out of the drain line until the backwashing tank is completely purged of air. Then water will flow to drain. Allow water to flow to drain for 15 minutes or until the water to drain is clear of resin color throw.
14. Plug the system back into the electrical outlet and manually cycle it through the remaining regeneration steps until it arrives in the service position.
15. Repeat installation steps 11, 12, 13, and 14 of the General Installation Instructions to purge the air from the second tank.
16. Check for leaks and repair as needed.
17. Installation is now complete and the system is ready for programming and one cycle of brine tank refill so that the correct amount of water is in the brine tank for the first regeneration cycle. The brine tank refill must be done after programming the system.

W100T System Programming

W100T Quick Programming Guide

A quick programming guide has been listed below for convenience specifically for the W100T series water softening systems. For other programming requirements not listed in the Quick Programming Guide, please see the detailed programming section of this manual.

CHART 1: User Display Screens

From Home screen press Next until Time of Day appears. Press and Hold Down for 5 seconds	Set Hours
Press Next	Set Minutes
Press Next	To Exit

CHART 2: OEM Set Up Screens

Press and Hold Next and Down for 5 seconds	Set to SOFTENING
Press Next	Set to dn
Press Next	Set to PoSt
Press Next	Set backwash length
Press Next	Set brine draw length
Press Next	Set 2nd backwash length
Press Next	Set rapid rinse length
Press Next	Set lbs of salt
Press Next	Set tank capacity (1000 grains)
Press Next	Set regen gallon capacity to "AUTo"
Press Next	Set type to "on 0"
Press Next	Set relay to "rELAY off"
Press Next	To Exit

CHART 3: Installer Display Settings

Press and Hold Next and Up for 5 seconds	Set hardness grains per gallon
Press Next	Set preferred regeneration day override
Press Next	On 0 will appear
Press Next	To Exit

NOTICE

The electronics in the W100T control valve are used across a wide variety of control valves and applications, including backwashing filters. All programming for the electronics has been included in this manual for reference however the valve must be programmed for Twin Alternating Softening Applications when called for during valve programming.

Regeneration and Error Screens



Regen Screen

Displays the time remaining in the current cycle. Pressing REGEN advances to the next cycle.

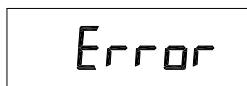

Error Screen

Alternated flashing Err and error code every 3 seconds. Clear by disconnecting the power supply at the PC board and reconnecting, or press NEXT and REGEN simultaneously for 3 seconds.



In Alternator Systems when a unit is waiting to initiate the first cycle step of regeneration, "REGEN Pndg" is displayed.

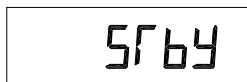

"STbY" is displayed in Alternator Systems when a valve is in Standby state.



"REGEN Pndg RINSE FILL" is displayed whenever a zero-capacity tank has transferred to an off-line state and is currently waiting to initiate the second portion of a regeneration cycle. Viewed only when Delayed Rinse and Fill is set to ON.

Button Operation and Function



Scrolls to the next display.

Pressing once and releasing will schedule a regeneration at the preset delayed regeneration time. Pressing again and releasing will cancel the regeneration.



Pressing and holding for 3 seconds will initiate an immediate regeneration. Pressing while in regeneration will advance to the next cycle. Pressing in the program levels will go backwards to the previous screen.



Changes variable being displayed.

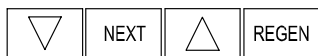

Key sequence to lock and unlock program settings.

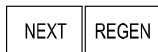

Holding for 3 seconds initiates a control reset. The software version is displayed and the piston returns to the home/service position, resynchronizing the valve.



Used with valve type 1.0Γ, holding for at least 3 seconds causes a switch in the tank in Service without cycling the regeneration valve. After tank switch, days remaining and capacity remaining status is retained for each tank until the next regeneration.

Regeneration Cycles and Times

Cycle	Range		
	Softening	Filtering Regen	Filtering Backwash
Backwash	1-120 minutes	1-120 minutes	1-120 min.
Regenerant Draw/Slow Rinse (UP or DN)	1-180 minutes	1-180 minutes	NA
Fast Rinse	1-120 minutes	1-120 minutes	1-120 min.
Regenerant Refill	0.1-200.0 lbs.	1-99.0 GAL	NA
Regenerant Refill 2.0 or 1.5 set to MIN (softening only)	0.1-99.0 minutes	0.1-99.0 minutes	NA
Service	1-480 minutes	NA	NA

If 1.5 or 2.0 is selected in Step 2CS, cycles can be set to "oFF".

The user can initiate manual regeneration. The user has the option to request the manual regeneration at the delayed regeneration time or to have the regeneration occur immediately:

1. Pressing and releasing the REGEN button. " REGEN TODAY" will flash on the display and the regeneration will occur at the delayed regeneration time. The user can cancel the request by pressing and releasing the REGEN button.
2. Pressing and holding the REGEN button for approximately 3 seconds will immediately start the regeneration. The user cannot cancel this request, except by resetting the control by pressing NEXT and REGEN simultaneously for 3 seconds.

User Displays

General Operation

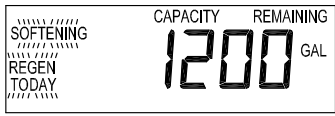

When the system is operating, one of five displays may be shown. Pressing NEXT will alternate between the displays shown below.

User 1

Typical user display. Shows volume remaining to regeneration. This screen will not be viewed if the control is set for time-clock operation.



User 2

Displays number of days to next regeneration.

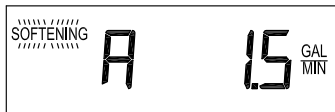

User 3

Flow Rate.

Displays present flow rate.

Not viewed (along with SOFTENING or FILTERING Icon) if ALT A or ALT b is set in CONFIGURATION 4 and the valve is currently in Standby. When 1.0Γ is set in CONFIGURATION 1, the display will indicate the tank currently in Service ("A" or "b") in the leftmost digit.



User 4

Displays total volume in gallons since last reset. If a meter is not used this display will be shown but 0 will be displayed.

PRESS ▼ FOR 3 SECONDS TO RESET TO 0.

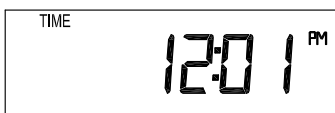

User 5

Shows current time.

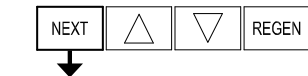

Setting Time of Day

Push NEXT until time of day screen is displayed. Press and hold ▼ until SET TIME is displayed and the hour flashes once. Press ▲ or ▼ until the correct hour is displayed.

Then press NEXT. The minutes will flash. Press ▲ or ▼ until the correct minute is displayed.

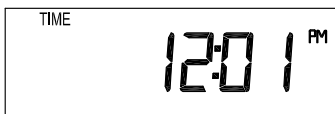

Press NEXT to return to the User Displays. Time of day should only need to be set after power outages lasting more than 8 hours, if the battery has been depleted and a power outage occurs, or when daylight saving time begins or ends. If a power outage lasting more than 8 hours occurs, the time of day will flash on and off which indicates the time of day should be reset. If a power outage lasts less than 8 hours and the time of day flashes on and off, the time of day should be reset and the battery replaced.



Configuration Settings

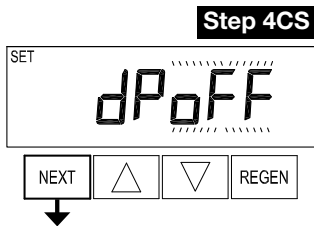
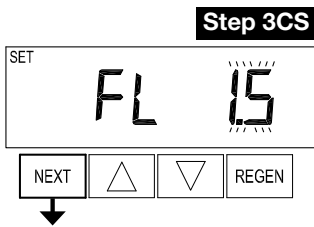
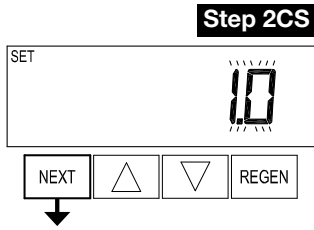
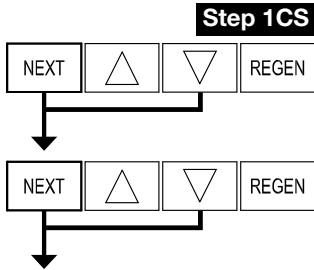

Step 1CS – Press NEXT and ▼ simultaneously for 5 seconds and release. Press NEXT and ▼ simultaneously for 5 seconds and release. If the screen in Step 2CS does not appear, the lock on the valve is activated. To unlock, press ▼, NEXT, ▲ and REGEN in sequence, then press NEXT and ▼ simultaneously for 5 seconds and release. Press NEXT and ▼ simultaneously for 5 seconds and release.

Step 2CS – Use ▲ or ▼ to select 1.0 for 1” valve, 1.25 for 1.25” valve, 1.5 for 1.5” valve, 2.0 for 2” valve or 1.0Γ for twin valve. If 1.0, 1.25 or 1.0Γ are selected, press NEXT to go to Step 4CS. If 1.5 or 2.0 are selected, press NEXT to go to Step 3CS. Press REGEN to exit Configuration Settings.

Step 3CS – Use ▲ or ▼ to select meter size. Settings available are 1.5, 2.0, 3.0, 1.0r (1.0 Remote Meter) or PUL (Variable Meter Calibration.) Variable meter pulses of 0.1-150.0 PPG can be selected. Press NEXT to go to Step 4CS. Press REGEN to return to previous step.

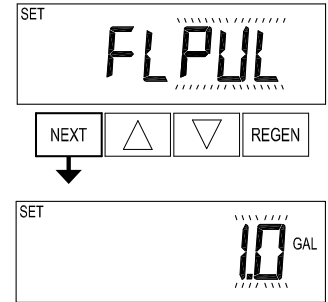

Step 4CS – Selecting the use of an outside signal to initiate a regeneration: Selection only matters if a connection is made to the two pin connector labeled DP SWITCH located on the printed circuit board. Following is an explanation of the options:
 oFF - feature not used
 NOTE: In a twin alternating system each control must have a separate dP signal or dP switch. One dP signal or one dP switch cannot be used for both controls.
 on0 – If the dP switch is closed for an accumulative time of 2 minutes a regeneration will be signaled to the unit. In a twin alternating system the MAV will transition first to switch units so that the signaled unit can start regeneration. After the MAV has fully transitioned, the regeneration begins immediately. Note: For WS1 – WS1.5 control valves programmed for twin alternating: if the dP function “on0” is set, the Delayed Rinse and Fill feature is not available.
 dEL – If the dP switch is closed for an accumulative time of 2 minutes a regeneration will occur at the scheduled delayed regeneration time. In a twin alternating system once the dP switch is triggered the PC Board will display “REGEN TODAY” and when the delayed regen time comes the control will switch tanks and the triggered unit will then go into regeneration. Note: For WS1 – WS1.5 control valves programmed for twin alternating: if the dP function “dEL” is set, the Delayed Rinse and Fill feature is not available.
 HoLd – If the dP switch is closed a regeneration will be prevented from occurring while there is switch closure. In a twin alternating system the regeneration of a unit can be prevented upon switch closure. If the unit depletes the capacity down to zero, it will not be allowed to switch tanks to regenerate until the switch is open. Note: For WS1 – WS1.5 control valves programmed for twin alternating the Delayed Rinse and Fill feature can be set.
 Press NEXT to go to Step 5CS. Press REGEN to return to previous step.

Step 5CS

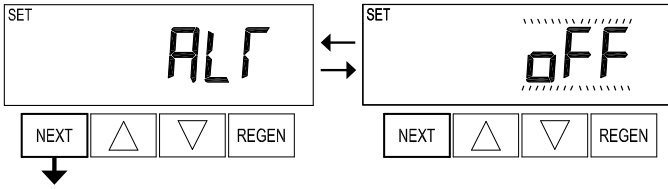

Step 5CS – This display will not appear if 1.0 Γ was selected in Step 2CS. Allows selection of one of the following using ▲ or ▼:

- the Control Valve to have no hard water bypass;
- the Control Valve to act as an alternator;
- the Control Valve to have a separate source during the regeneration cycle; or
- the Control Valve to operate with the System Controller.

Select OFF when none of these features are used.

Only use Watts No Hard Water Bypass Valves or Watts Motorized Alternating Valves (MAV) with these selections. Watts No Hard Water Bypass Valves (1" or 1.25" V3070FF or V3070FM) are not designed to be used with the alternator or separate source functions.

Configuring the Control Valve for No Hard Water Bypass Operation:

Select nHbP for control operation. For no hard water bypass operation the three wire communication cable is not used.



Selection requires that a connection to MAV or a No Hard Water Bypass Valve is made to the two pin connector labeled MAV located on the printed circuit board. If using a MAV, the A port of the MAV must be plugged and the valve outlet connected to the B port. When set to nHbP the MAV will be driven closed before the first regeneration cycle that is not FILL or SOFTENING or FILTERING, and be driven open after the last regeneration cycle that is not FILL.

NOTE: If the control valve enters into an error state during regeneration mode, the no hard water bypass valve will return to the open Position, if not already there.

Configuring the Control Valve for Separate Source Operation:

Select SEPS for control operation. For separate source operation the three wire communication cable is not used.



Selection requires that a connection to a Watts Motorized Alternator Valve (MAV) is made to the two pin connector labeled MAV located on the printed circuit board. The C port of the MAV must be connected to the valve inlet and the A port connected to the separate source used during regeneration. The B port must be connected to the feed water supply.

When set to SEPS the MAV will be driven closed before the first regeneration cycle, and be driven open after the last regeneration cycle.

NOTE: If the control valve enters into an error state during regeneration mode, the MAV will return to the open position, if not already there.

Selecting the Control Valve to act as an alternator:

519.0 and higher = Use 3-wire Interconnect Cables for all communication between units.
 518.3 and lower = Use 2-wire Interconnect Cables for twin alternators with independent flow meters.

Prior to starting the programming steps, connect the communication cable to each control valve board's three pin connector labeled 'COMM CABLE'. Also connect the meter cord to either control valve to the three pin connector labeled 'METER'.			
Softener Valve Programming Steps			
Configuration Settings	Step 5CS	Set to ALT A Connect the outlet plumbing of ALT A valve to the MAV's A port and connect the MAV's two pin wire connector to the two pin connector labeled "DRIVE" on the ALT A valve	Set to ALT b Connect the outlet plumbing of ALT b valve to the MAV's B port. No electrical connections are required between the ALT b valve and the MAV.
Softener System Setup	Step 10S	Set System Capacity	Set System Capacity
Softener System Setup	Step 11S	Set to 'AUTO'	Set to 'AUTO'
Softener System Setup	Step 12S	Set regeneration time option to 'on 0'.	Set regeneration time option to 'on 0'.
Installer Display Settings	Step 3I	Set Day Override to "oFF"	Set Day Override to "oFF"

If set up for a filter, in Step 5F set Volume Capacity in Gallons; in Step 6F select Regeneration Time Option "on 0"; and in Step 3I select Day Override "oFF".

NOTE: If the control valve is in an error state during regeneration mode the MAV will close the B port and keep open the A port until the error is corrected and reset.

WS1, WS1.25 and WS1.5 Valves

For Watts alternator systems using WS1, WS1.25 and WS1.5 valves there will be an option to delay the last two cycles of regeneration (only “Rinse” and “Fill”). This feature splits the regeneration into two portions. The first portion of the regeneration will start immediately and all programmed cycles before the “Rinse” and “Fill” cycles will be performed. After all programmed cycles before “Rinse” and “Fill” are completed the control valve will drive to the service position (displaying “Delayed Rinse + Fill Pending”). When the volume of the on-line unit is depleted to 10% of its programmed capacity, the control valve will be triggered to finish the second portion of the regeneration and complete the “Rinse” and “Fill” cycles and return to Service and be placed into Standby mode, and wait to come on-line for service. Set to OFF to deactivate this feature.

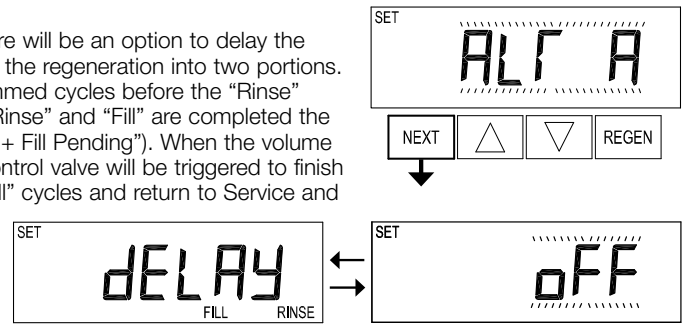

WS2 Valve

For Watts alternator systems using the WS2 valve, when NEXT is pressed after selecting ALT A or ALT B, a display will allow the user to set the amount of pre-service rinse time for the stand by tank just prior to returning to service. Set to OFF to deactivate this feature. With 1.0Γ set, the same display appears and is set in a similar manner.

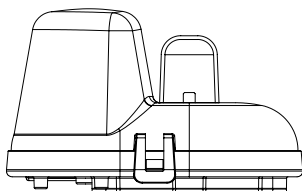
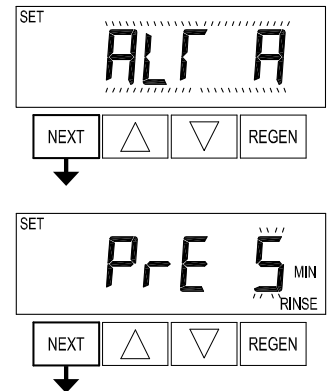

Retracted

Valve “A” in Service Position = MAV piston rod Retracted

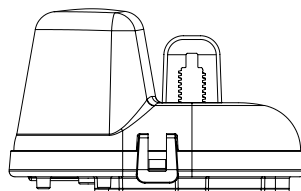

Extended

Valve “B” in Service Position = MAV piston rod Extended

NOTICE

Watts Twin Alternator Operations

- Twin alternating systems can be programmed with a day override setting combined with the normal volume-based regeneration programming. A twin alternating system in this configuration will then regenerate based on the volume used or the day override if there is a period of low water usage.
- Twin alternating systems can be programmed as a time clock only based regenerating system. In this configuration, the days remaining are counted only on the unit that is in service. The unit in Stand-by Mode only notes days in diagnostics, which results in time clock only twin regeneration initiation.
- Twin alternating systems can be programmed for a delayed regeneration time. The system will allow an immediate transfer of the MAV to switch tanks and place a fully regenerated unit in service once a unit becomes exhausted. The exhausted unit will then be placed into Stand-by Mode and allowed to have a delayed regeneration at the pre-set time.

Configuring the Control Valve for System Controller Operation:

Select "SYS" to link control valve to System Controller. For communication between control valve and System Controller, a three-wire communication cable is required.

Selection requires that a connection to a Watts No Hard Water Bypass (V3070FF or V3070FM) be made to the two-pin connector labeled MAV located on the printed circuit board for WS1 and WS1.25 control valves. For valve types WS1.5 and WS2, a connection from a Watts No Hard Water Bypass (V3097/ BSPT or V3098/ BSPT) to the two pin connector labeled MAV located on the printed circuit board is required.

Press NEXT to go to Step 6CS. Press REGEN to return to previous step.

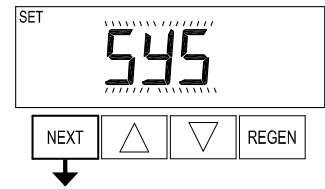

Step 6CS

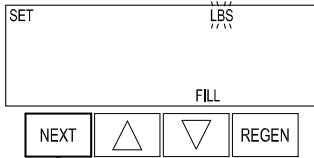

EXIT TO DISPLAY SCREENS

Step 6CS – Fill Units: If set as a softener, if Step 2CS is set to 1.5, and FILL is part of the Regeneration Cycle Sequence, FILL UNITS of MIN or LBS can be selected. Press NEXT to exit OEM Configuration Setup. Press REGEN to return to previous step.



OEM Softener System Setup

Step 1S

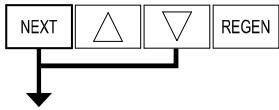

Step 1S - Press NEXT and ▼ simultaneously for 5 seconds and release. If screen in Step 2S does not appear, the lock on valve programming has been activated. To unlock press ▼, NEXT, ▲, REGEN in sequence, then press NEXT and ▼ simultaneously for 5 seconds and release.

Step 2S

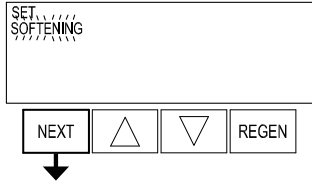

Step 2S - Choose SOFTENING using ▲ or ▼. Press NEXT to go to Step 3S. Press REGEN to exit OEM Softener System Setup.

Step 3S

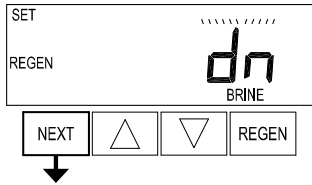

Step 3S - Choose Brining Direction using ▲ or ▼. This screen is not viewed when Step 2S is set to Filtering. Press NEXT to go to Step 4S. Press REGEN to return to previous step.

Step 4S

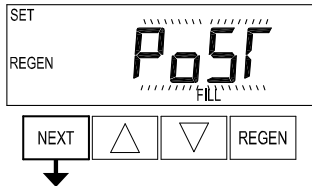

Step 4S - Set Refill location using ▲ or ▼:
 • “PoST” to refill the brine tank after the final rinse; or
 • “PrE” to refill the brine tank four hours before the regeneration time set.
 This screen is not viewed when Step 2S is set to Filtering.
 Press NEXT to go to Step 5S. Press REGEN to return to previous step.

Step 5S

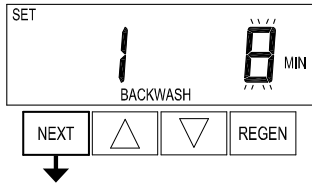

Step 5S - Select the time for the first cycle using ▲ or ▼. For valve types 1.5 and 2.0, “oFF” is also available.
 Press NEXT to go to Step 6S. Press REGEN to return to previous step.

Step 6S

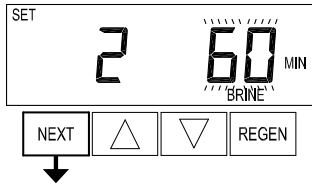

Step 6S - Select the time for the second cycle using ▲ or ▼. For valve types 1.5 and 2.0, “oFF” is also available.
 NOTE: The display will flash between cycle number and time, and brine direction (UP or dn).
 Press NEXT to go to Step 7S. Press REGEN to return to previous step.

Step 7S

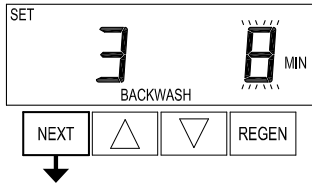

Step 7S - Select the time for the third cycle using ▲ or ▼. For valve types 1.5 and 2.0, “oFF” is also available.
 Press NEXT to go to Step 8S. Press REGEN to return to previous step.

Step 8S

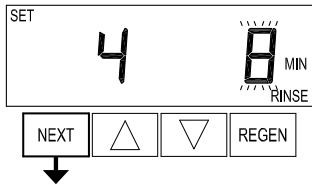

Step 8S - Select the time for the fourth cycle using ▲ or ▼. For valve types 1.5 and 2.0, “oFF” is also available.
 Press NEXT to go to Step 9S. Press REGEN to return to previous step.

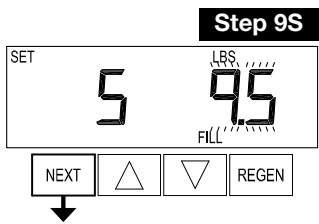

Step 9S – Select the pounds for the fifth cycle using ▲ or ▼. For valve types 1.5 and 2.0, “oFF” is also available.
 NOTE: if Step 2CS is set to 2.0 or Step 7CS is set to MIN, Fill will be in minutes.
 Press NEXT to go to Step 10S. Press REGEN to return to previous step.

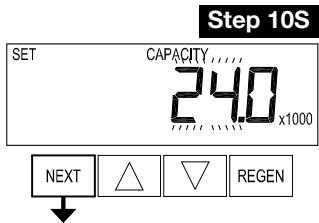

Step 10S – Set System Capacity using ▲ or ▼. The System Capacity setting should be based on the volume of resin and salt fill set in Step 9S. Press NEXT to go to Step 11S. Press REGEN to return to previous step.

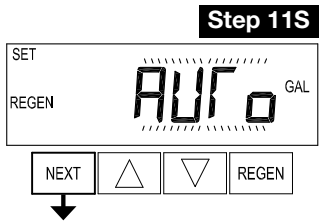

Step 11S – Set Volume Capacity using ▲ or ▼. If value is set to:

- “AUTO” capacity will be automatically calculated and reserve capacity will be automatically estimated;
- “oFF” regeneration will be triggered solely by the day override setting (see Installer Display/Settings Step 4);
- a number, regeneration will be triggered by the value specified (in Gallons).

If “oFF” or a volume is used, the hardness display will not be allowed to be set in Installer Display Settings Step 2I. See Setting Options Table for more detail. Press NEXT to go to Step 12S. Press REGEN to return to previous step.

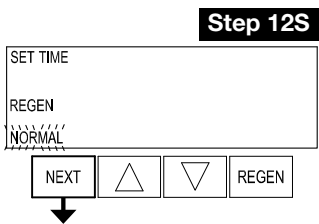

Step 12S – Set Regeneration Time Options using ▲ or ▼. If value is set to:

- “NORMAL” means regeneration will occur at the preset time;
- “on 0” means regeneration will occur immediately when the volume capacity reaches 0 (zero); or
- “NORMAL + on 0” means regeneration will occur at one of the following:
 - the preset time when the volume capacity falls below the reserve or the specified number of days between regenerations is reached whichever comes first;
 - immediately after 10 minutes of no water usage when the volume capacity reaches 0 (zero).

“NORMAL” is the default if Step 5CS is set to ALT A or ALT B, and “NORMAL + on 0” is not available.
 “on 0” is the default if Step 2CS is set to 1.0 Γ, and “NORMAL + on 0” is not available.
 This step will not appear if Step 11S is set to oFF or Step 5CS is set to “SYS”.
 See Setting Options Table for more detail. Press NEXT to go to Step 13S. Press REGEN to return to previous step.

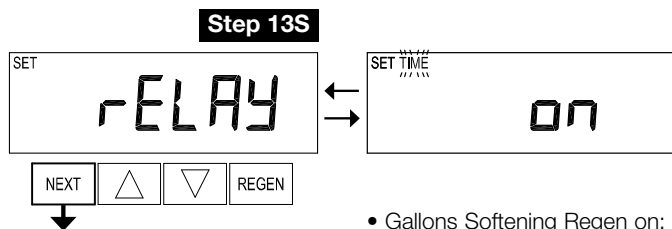

Step 13S – Set Relay Operation using ▲ or ▼. The choices are:

- Time on: Relay activates after a set time at the beginning of a regeneration and then deactivates after a set period of time. The start of regeneration is defined as the first backwash cycle or Dn brine cycle, whichever comes first.
- Gallons Softening on: Relay activates after a set number of gallons have been used while in service and then deactivates after the meter stops registering flow and the set time period has expired.
- Gallons Softening Regen on: Relay activates after a set number of gallons have been used while in service, or during regeneration, and then deactivates after the meter stops registering flow and the set time period has expired.
- ERROR: Relay closes whenever the valve enters error mode, and immediately deactivates when error mode is exited. If set to ERROR, Steps 14S and 15S will not be shown.
- Off: If set to Off, Steps 14S and 15S will not be shown.

Press NEXT to go to Step 14S. Press REGEN to return to previous step.

Step 14S

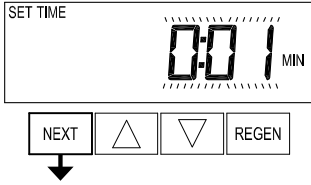

Step 14S – Set Relay Actuation Time or Gallons using ▲ or ▼. The choices are:

- Relay Actuation Time: After the start of a regeneration the amount of time that should pass prior to activating the relay. The start of regeneration is defined as the first backwash cycle, Dn brine cycle or UP brine cycle whichever comes first. Ranges from 1 second to 200 minutes.
- Relay Actuation Gallons: Relay activates after a set number of gallons has passed through the meter. Ranges from 1 to 200 gallons.

Press NEXT to go to Step 15S. Press REGEN to return to previous step.

Step 15S

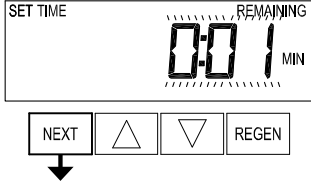

Step 15S – Set Relay Deactivate Time using ▲ or ▼.

- If Set Time on is selected in Step 13S the relay will deactivate after the time set has expired. Ranges from 1 second to 200 minutes.
- If Set Gallons Softening on or Set Gallons Softening Regen on is selected in Step 13S the relay will deactivate after the time set has expired or after the meter stops registering flow, whichever comes first. Ranges from 1 second to 20 minutes.

Press NEXT to exit OEM Softener System Setup. Press REGEN to return to previous step.

EXIT OEM SOFTENER SYSTEM SETUP

Setting Options Table

Filters should only use shaded options

Volume Capacity	Regeneration Time Option	Day Override	Result ¹
AUTO	NORMAL	oFF	Reserve capacity automatically estimated. Regeneration occurs when volume capacity falls below the reserve capacity at the next Regen Set Time.
AUTO	NORMAL	Any number	Reserve capacity automatically estimated. Regeneration occurs at the next Regen Set Time when volume capacity falls below the reserve capacity or the specified number of days between regenerations is reached.
Any number	NORMAL	oFF	Reserve capacity <u>not</u> automatically estimated. Regeneration occurs at the next Regen Set Time when volume capacity reaches 0.
oFF	NORMAL	Any number	Reserve capacity <u>not</u> automatically estimated. Regeneration occurs at the next Regen Set Time when the specified number of days between regenerations is reached.
Any number	NORMAL	Any number	Reserve capacity <u>not</u> automatically estimated. Regeneration occurs at the next Regen Set Time when volume capacity reaches 0 or the specified number of days between regenerations is reached.
AUTO	On 0	oFF	Reserve capacity <u>NOT</u> automatically estimated. Regeneration occurs immediately when volume capacity reaches 0. Time of regeneration will not be allowed to be set because regeneration will always occur when volume capacity reaches 0.
Any number	On 0	oFF	Reserve capacity <u>NOT</u> automatically estimated. Regeneration occurs immediately when volume capacity reaches 0. Time of regeneration will not be allowed to be set because regeneration will always occur when volume capacity reaches 0.
AUTO	NORMAL on 0	oFF	Reserve capacity automatically estimated. Regeneration occurs when volume capacity falls below the reserve capacity at the next Regen Set Time or regeneration occurs after 10 minutes of no water usage when volume capacity reaches 0.
AUTO	NORMAL on 0	Any number	Reserve capacity automatically estimated. Regeneration occurs at the next Regen Set Time when volume capacity falls below the reserve capacity or the specified number of days between regenerations is reached or regeneration occurs after 10 minutes of no water usage when volume capacity reaches 0.
Any number	NORMAL on 0	Any number	Reserve capacity <u>not</u> automatically estimated. Regeneration occurs at the next Regen Set Time when the specified number of days between regenerations is reached or regeneration occurs after 10 minutes of no water usage when volume capacity reaches 0.

OEM Filter System Setup

Cycle Sequence, Adjustable Default Times (minutes)						
Type	Backwash	Draw	Backwash	Rinse	Backwash*	Fill
Filtering Backwash	8			4		
Filtering Regen	8	60	8	8	0:30	.95 GAL
Filtering Regen (2.0")	8	60	8	8	0:30	6

*Cycle is non-adjustable, not shown in cycle sequence programming.

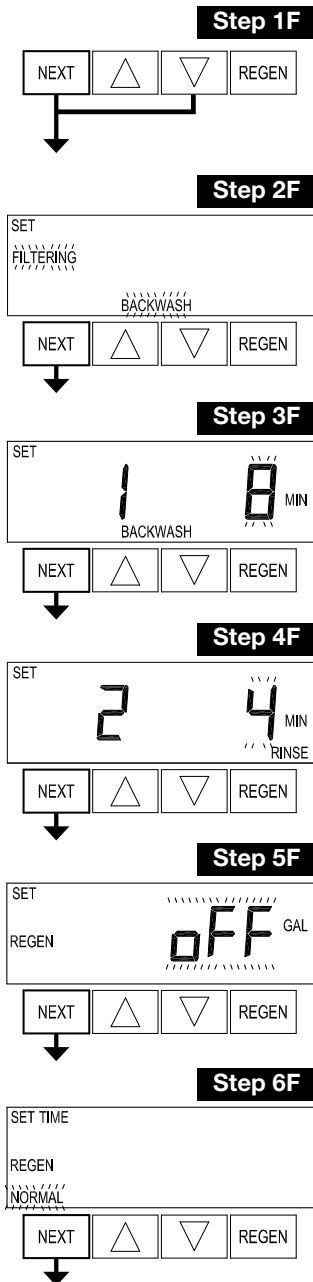

Step 1F - Press NEXT and ▼ simultaneously for 5 seconds and release. If screen in Step 2CS does not appear, the lock on the valve is activated. To unlock press ▼, NEXT, ▲, REGEN in sequence, then press NEXT and ▼ simultaneously for 5 seconds and release.

Step 2F - Choose FILTERING BACKWASH or FILTERING REGEN (see table) using ▲ or ▼. Press NEXT to go to Step 3F. Press REGEN to exit OEM Filter System Setup.

Step 3F - Select the time for the first cycle using ▲ or ▼. Press NEXT to go to Step 4F. Press REGEN to return to previous step.

Step 4F - Select the time for the second cycle using ▲ or ▼. If Step 2F is set to FILTERING REGEN, press NEXT to program the rest of the cycle times. If Step 2F is set to FILTERING BACKWASH, press NEXT to go to Step 5F. Press REGEN to return to previous step.

Step 5F - Set Regeneration trigger using ▲ or ▼. If value is set to:

- “oFF” regeneration will be triggered solely by the day override setting (see Installer Display/Settings Step 4I);
- a number, regeneration will be triggered by the value specified (in gallons). See Setting Options Table for more detail.

Press NEXT to go to Step 6F. Press REGEN to return to previous step.

Step 6F - Set Regeneration Time Options using ▲ or ▼. If value is set to:

- “NORMAL” means regeneration will occur at the preset time;
- “on 0” means regeneration will occur immediately when the volume capacity reaches 0 (zero); or
- “NORMAL + on 0” means regeneration will occur at one of the following:
 - the preset time when the volume capacity falls below the reserve or the specified number of days between regenerations is reached whichever comes first; or
 - immediately after 10 minutes of no water usage when the volume capacity reaches 0 (zero).

“NORMAL” is the default if Step 5CS is set to ALT A or ALT B, and “NORMAL + on 0” is not available.
 “on 0” is the default if Step 2CS is set to 1.0Γ, and “NORMAL + on 0” is not available.
 This step will not appear if Step 5F is set to off or Step 5CS is set to “SYS”.
 See Setting Options Table for more detail. Press NEXT to go to Step 7F. Press REGEN to return to previous step.

Step 7F

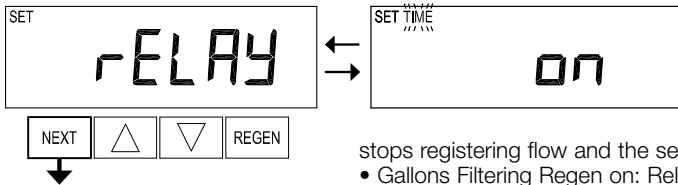

- Step 7F** – Set Relay Operation using ▲ or ▼. The choices are:
- Time on: Relay activates after a set time at the beginning of a regeneration and then deactivates after a set period of time. The start of regeneration is defined as the first backwash cycle or Dn brine cycle, whichever comes first.
 - Gallons Filtering on: Relay activates after a set number of gallons have been used while in service and then deactivates after the meter stops registering flow and the set time period has expired.

• Gallons Filtering Regen on: Relay activates after a set number of gallons have been used while in service, or during regeneration, and then deactivates after the meter stops registering flow and the set time period has expired.

• ERROR: Relay closes whenever the valve enters error mode, and immediately deactivates when error mode is exited. If set to ERROR, Steps 8F and 9F will not be shown.

• Off: If set to Off, Steps 8F and 9F will not be shown.

Press NEXT to go to Step 8F. Press REGEN to return to previous step.

Step 8F

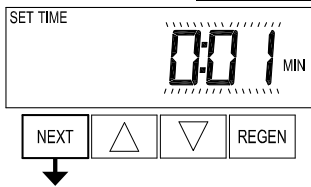

- Step 8F** – Set Relay Actuation Time or Gallons using ▲ or ▼. The choices are:
- Relay Actuation Time: After the start of a regeneration the amount of time that should pass prior to activating the relay. The start of regeneration is defined as the first backwash cycle or brine cycle, whichever comes first. Ranges from 1 second to 200 minutes.
 - Relay Actuation Gallons: Relay activates after a set number of gallons has passed through the meter. Ranges from 1 to 200 gallons.
- Press NEXT to go to Step 9F. Press REGEN to return to previous step.

Step 9F

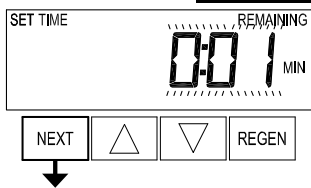

- Step 9F** – Set Relay Deactivate Time using ▲ or ▼.
- If Set Time on is selected in Step 7F the relay will deactivate after the time set has expired. Ranges from 1 second to 200 minutes.
 - If Set Gallons Filtering on or Set Gallons Filtering Regen on is selected in Step 7F the relay will deactivate after the time set has expired or after the meter stops registering flow, whichever comes first. Ranges from 1 second to 20 minutes.
- Press NEXT to exit OEM Filter System Setup. Press REGEN to return to previous step.

EXIT OEM FILTER SYSTEM SETUP

Installer Display Settings

Step 1I

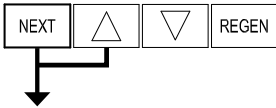

Step 1I - To enter Installer Display press NEXT and ▲ simultaneously for about 5 seconds and release.

Step 2I

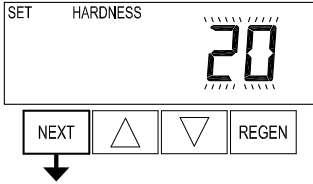

Step 2I – Hardness: Set the amount of influent hardness using ▲ or ▼. This display will not be viewed if FILTERING BACKWASH or FILTERING REGEN is selected in Step 2F or if “oFF” or a number was selected in Step 11S. Press NEXT to go to step 3I. Press REGEN to exit Installer Display Settings.

Step 3I

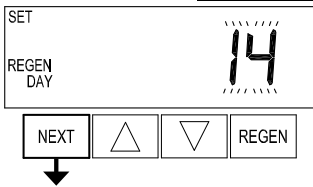

Step 3I – Day Override: When volume capacity is set to “oFF”, sets the number of days between regenerations. When volume capacity is set to AUTO or to a volume, sets the maximum number of days between regenerations. If value set to “oFF”, regeneration initiation is triggered solely by volume used. If value is set in days (allowable range from 1 to 28) regeneration initiation will be called for on that day regardless of actual water usage. Set Day Override using ▲ or ▼:

- number of days between regeneration (1 to 28); or
- “oFF”.

See Setting Options Table for more detail on setup. Press NEXT to go to step 4I. Press REGEN to return to previous step.

Step 4I

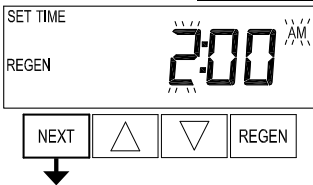

Step 4I – Next Regeneration Time (hour): Set the hour of day for regeneration using ▲ or ▼. The default time is 2:00. This display will show “REGEN on 0 GAL” if “on 0” is selected in Set Regeneration Time Option in OEM Softener System Setup or OEM Filter System Setup. Press NEXT to go to step 5I. Press REGEN to return to previous step.

Step 5I

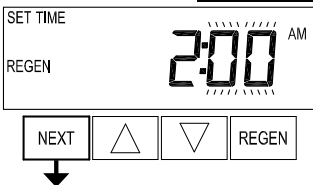

Step 5I – Next Regeneration Time (minutes): Set the minutes of day for regeneration using ▲ or ▼. This display will not be shown if “on 0” is selected in Set Regeneration Time Option in OEM Softener System Setup or OEM Filter System Setup. Press NEXT to exit Installer Display Settings. Press REGEN to return to previous step.

EXIT INSTALLER DISPLAY SETTINGS

Diagnostics

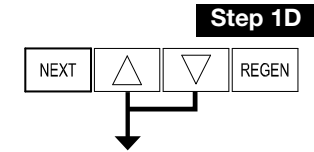

Step 1D - Press ▲ and ▼ simultaneously for 5 seconds and release. If screen in Step 2D does not appear the lock on the valve is activated. To unlock press ▼, NEXT, ▲, REGEN in sequence, then press ▲ and ▼ simultaneously for 5 seconds and release.

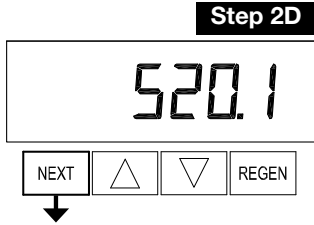

Step 2D - Software Version. Press NEXT to go to Step 3D. Press REGEN to exit Diagnostics.

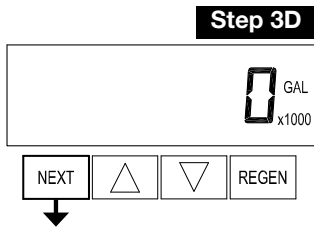

Step 3D - Volume, total used since start-up: This display shows the total gallons treated since startup. This display will equal zero if a water meter is not installed. Press the NEXT button to go to Step 4D. Press REGEN to return to previous step.

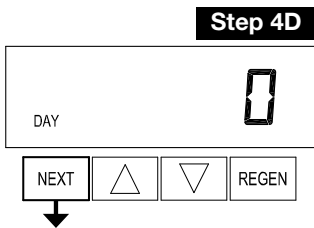

Step 4D - Days, total since start-up: This display shows the total days since startup. Press the NEXT button to go to Step 5D. Press REGEN to return to previous step.

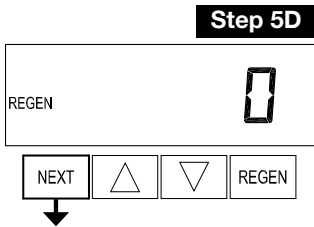

Step 5D - Regenerations, total number since start-up: This display shows the total number of regenerations that have occurred since startup. Press the NEXT button to go to Step 6D. Press REGEN to return to previous step.

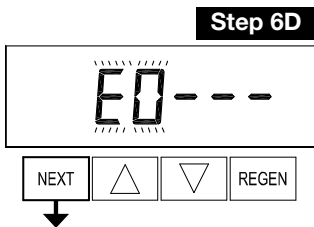

Step 6D - Error Log: This display shows a history of the last 10 errors generated by the control during operation. Press ▲ or ▼ to view each recorded error. Press NEXT to go to Step 7D. Press REGEN to return to previous step.

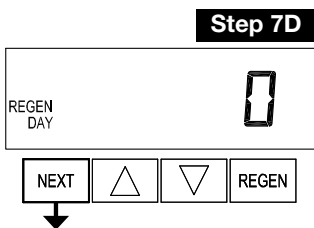

Step 7D - Days, since last regeneration: This display shows the days since the last regeneration occurred. Press NEXT to go to Step 8D. Press REGEN to return to previous step.

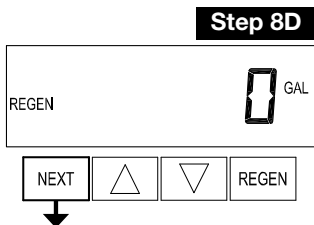

Step 8D - Volume, since last regeneration: This display shows the volume of water that has been treated since the last regeneration. This display will equal zero when a water meter is not installed. Press NEXT to go to Step 9D. Press REGEN to return to previous step.

Step 9D

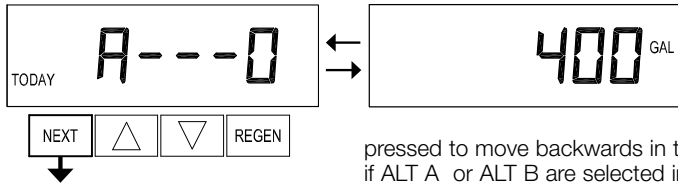

Step 9D – Volume, reserve capacity used for last 7 days: If the valve is set up as a softener, a meter is installed, and Set Volume Capacity is set to “Auto,” this display shows day 0 (for today) and flashes the reserve capacity. Pressing ▲ will show day 1 (which would be yesterday) and flashes the reserve capacity used. Pressing ▲ again will show day 2 (the day before yesterday) and the reserve capacity. Keep pressing ▲ to show the capacity for days 3, 4, 5 and 6. ▼ can be pressed to move backwards in the day series. This display does not appear if 1.0Γ is set in Step 2CS, if ALT A or ALT B are selected in Step 5CS, or anytime the reserve capacity is not determined by the control.

Press NEXT at any time to go to Step 10D. Press REGEN to return to previous step.

Step 10D

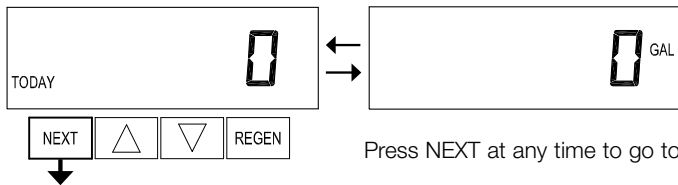

Press NEXT at any time to go to Step 11D. Press REGEN to return to previous step.

Step 11D

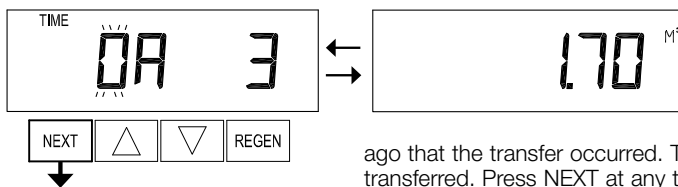

Step 11D – Twin Tank Valve transfer history: only displays when 1.0Γ was selected in Step 2CS. Use ▲ or ▼ to scroll through the last 10 tank transfers. The first position in the display ranges from 0 to 9 with the lowest number being the most recent transfer. The second position in the display will be either “A” or “b”. If “A” then the tank with the valve on it was in service, if “b” the tank with the in/out head on it was in service. The next three digits represent the number of hours ago that the transfer occurred. The display alternates with the volume that was treated before the tank transferred. Press NEXT at any time to go to Step 12D. Press REGEN to return to previous step.

Step 12D

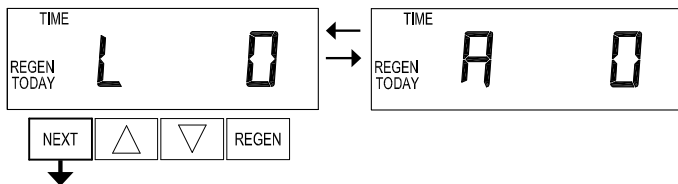

Step 12D – MAV Drive History in the direction of retracted piston rod position. Display will only be shown if 1.0Γ is selected in Step 2CS, or OFF is not selected in Step 5CS. Up to a four digit number will appear after the “L” which stands for latest and “A” which stands for average. Drive time is measured in 1/100 of a second; i.e., a 17.10 second move is displayed as “1710”. Press NEXT at any time to go to Step 13D. Press REGEN to return to previous step.

Press and hold ▲ and ▼ buttons for 3 seconds while in Step 12D to reset the MAV drive history in both the retracted and extended piston rod position. To view the old MAV drive history data for retracted and extended rod position press and hold REGEN and ▲ while in Step 12D. Press NEXT to advance display to the old MAV drive history.

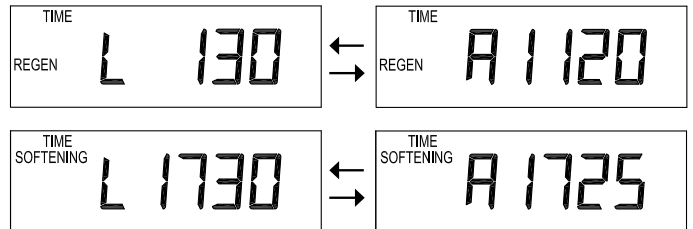

Step 13D

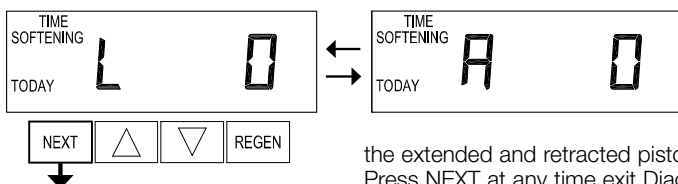

Step 13D – MAV Drive History in the direction of extended piston rod position. Display will only be shown if 1.0Γ is selected in Step 2CS, or OFF is not selected in Step 4CS. Up to a four digit number will appear after the “L” which stands for latest and “A” which stands for average. Drive time is measured in 1/100 of a second; i.e., a 17.15 second move is displayed as “1715”. Press and hold ▲ and ▼ for 3 seconds while in Step 13D to reset the MAV drive history in both the extended and retracted piston rod position. To view the old MAV drive history data see Step 12D. Press NEXT at any time exit Diagnostics. Press REGEN to return to previous step.

EXIT DIAGNOSTICS

W100T Part List and Drawings

Front Cover and Drive Assembly

Drawing No.	Order No.	Description	Quantity
1	V3175EE-01	W100T Front Cover Assembly	1
2	V3107-01	W100T Motor	1
3	V3106-01	W100T Drive Bracket & Spring Clip	1
4	V3408EE-03BOARD	W100T THRU 2L/2 EEPICBRD MAV/ALT REPL	1
5	V3110	W100T Drive Gear 12x36	3
6	V3109	W100T Drive Gear Cover	1
Not Shown	V3186	W100T AC ADAPTER 120V-12V	1
	V3186-01	W100T AC ADAPTER CORD ONLY	
Not Shown	V3178	W100T Drive Back Plate	1

Refer to Control Valve Service Manual for other drawings and part numbers.

AC Adapter	U.S.	International
Supply Voltage	120 V AC	230V AC
Supply Frequency	60 Hz	50 Hz
Output Voltage	12 V AC	12 V AC
Output Current	500 mA	500 mA

When replacing the battery, align positives and push down to fully seat.

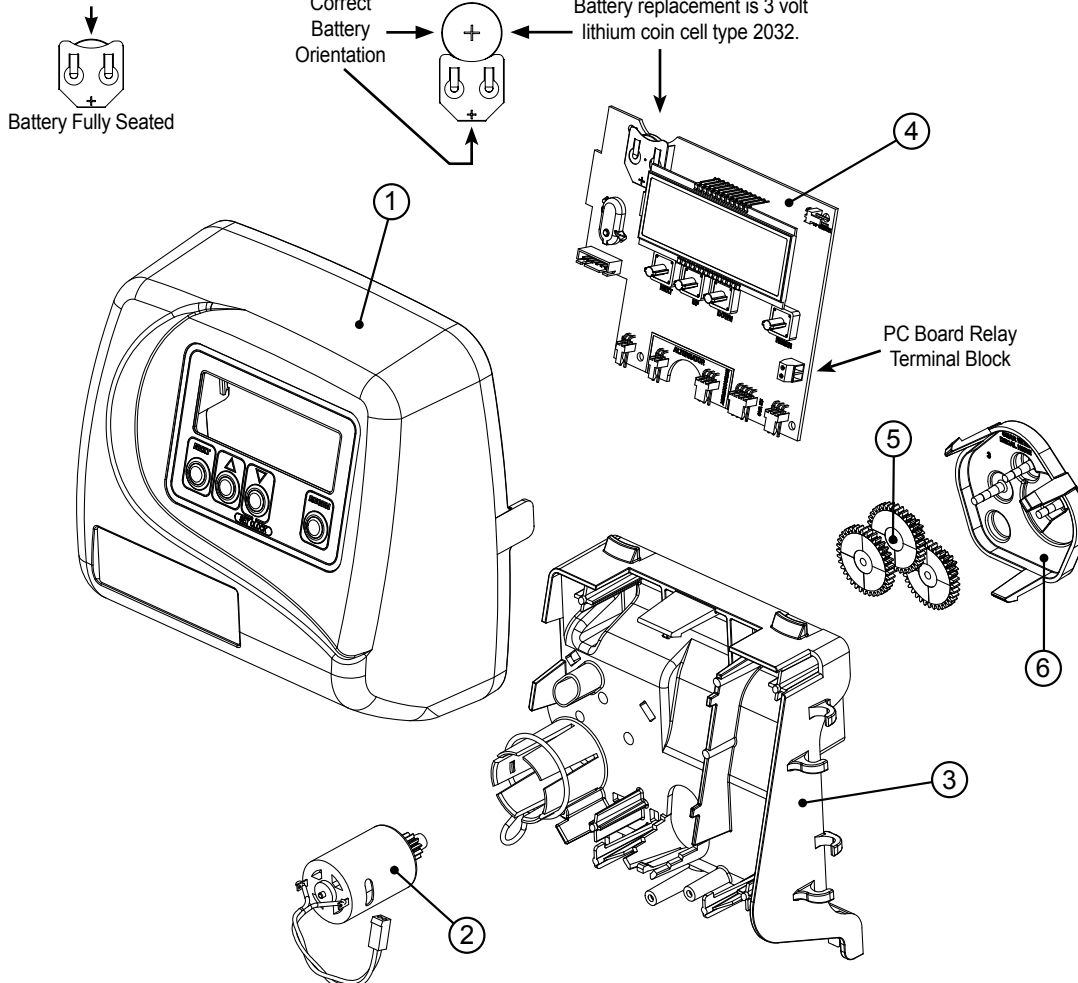

Valve Body Compliance Table

Application	Injector and/or Plug(s)	Main Piston	Regenerant Piston	Stack	Body*
1" Downflow Softener or Regenerating Filter	Injector in "DN" hole, Plug in "UP" hole	V3011	V3174	V3005	V3031
1" Backwash Only Filter	Plug in "DN" and "UP" holes, Install Refill Port Plug	V3011	None	V3005	V3031
1" Upflow Softener	Injector in "UP" hole, Plug in unlabeled hole	V3011-01	V3174	V3005	V3031

W100T with 1.050" Distributor Tube Opening Identification

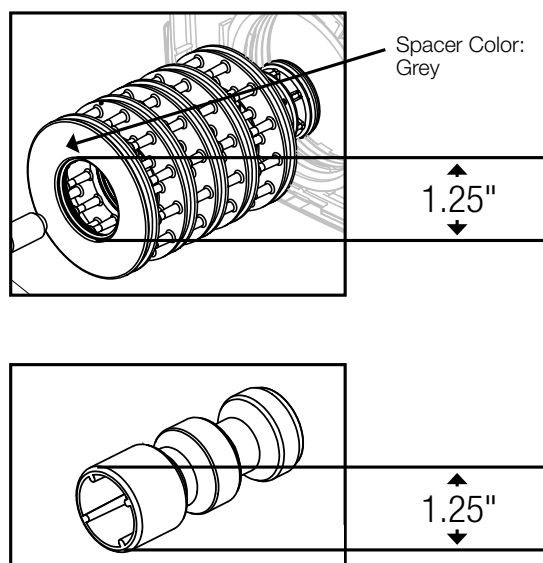

NOTICE

The downflow piston is a solid amber color. The upflow piston is black and amber.

Drive Cap Assembly, Downflow Piston, Upflow Piston, Regenerant Piston and Spacer Stack Assembly

Drawing No.	Order No.	Description	Quantity
1	V3005	W100T Spacer Stack Assembly	1
2	V3004	Drive Cap ASY	1
3a	V3011*	W100T Piston Downflow ASY	1
3b	V3011-01*	W100T Piston Upflow ASY	
4	V3174	W100T Regenerant Piston	1
5	V3135	O-ring 228	1

*V3011 is labeled with DN and V3011-01 is labeled with UP. Upflow option is not applicable to EA, EE or EI control valves.

NOTICE

The regenerant piston is not used in backwash only applications.

Refer to programming and Cover Drawing Manual

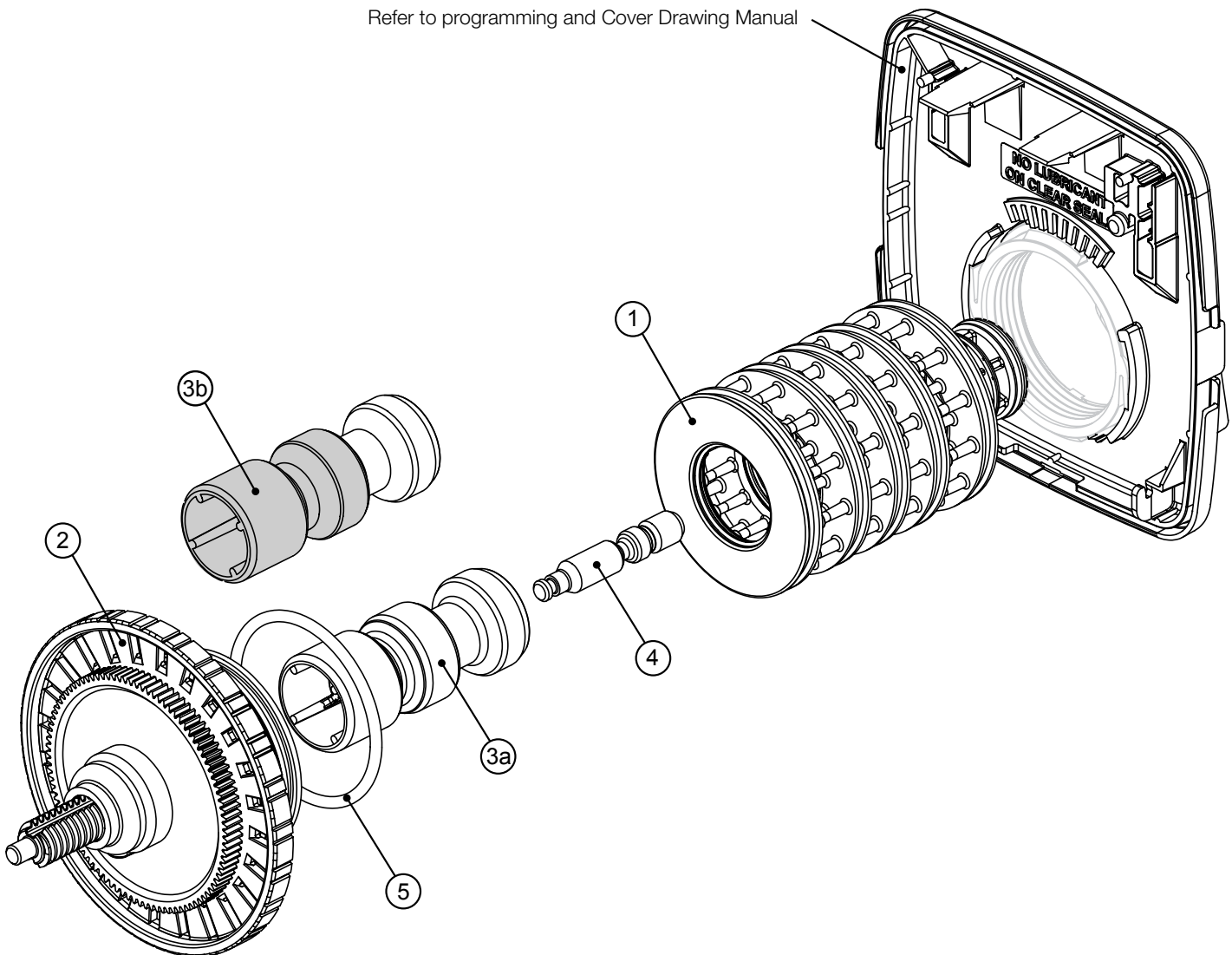

Twin Transfer

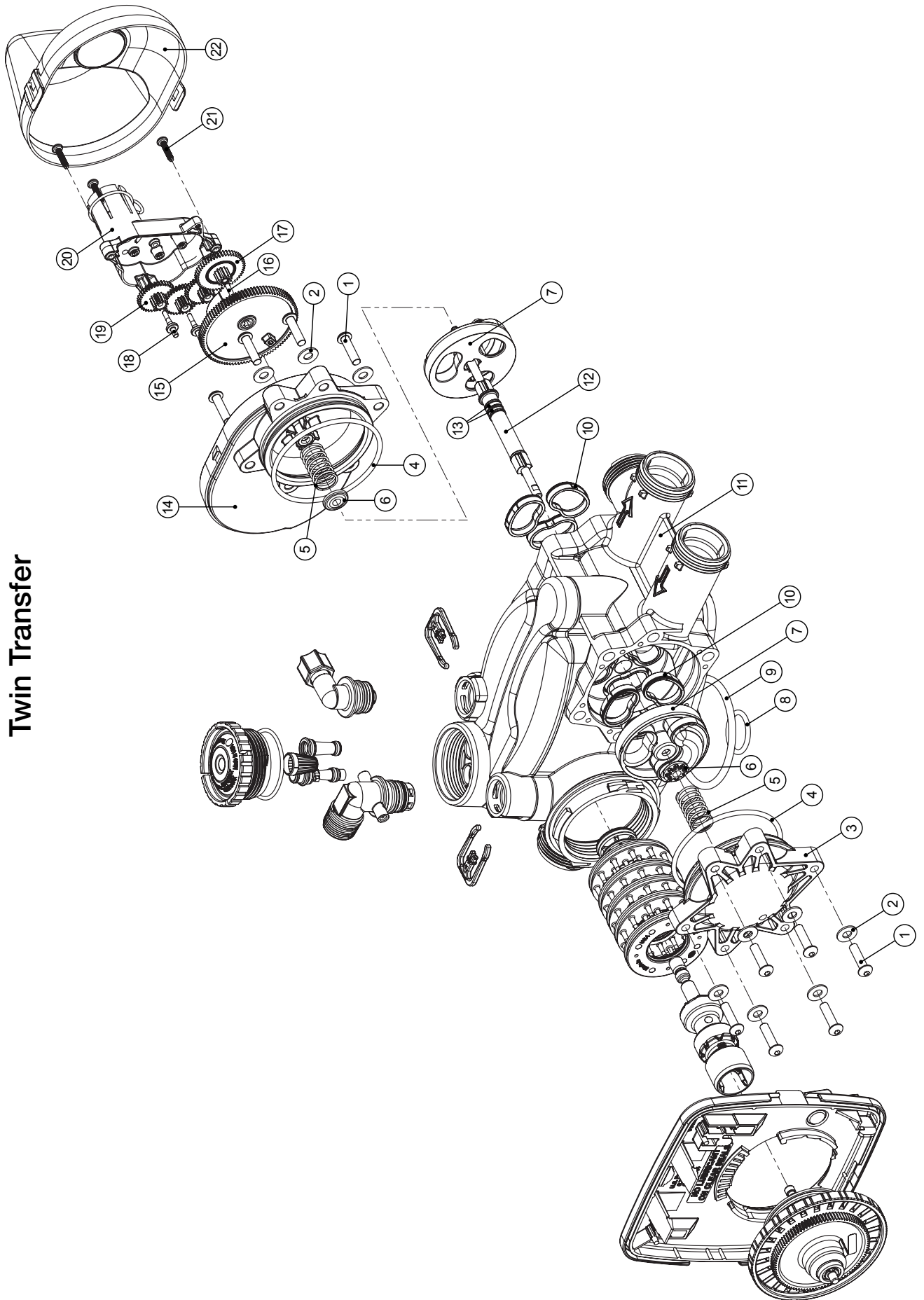

Twin Transfer (continued)

Drawing No.	Order No.	Description	Quantity
1	V3470	SCREW BHC 1/4-20 X 1 SS	12
2	V3724	WASHER FLAT SS 1/4	12
3	V4005-01	T1 TRANSFER CAP ASY	1
4	V4029	O-RING 236	2
5	V4015	T1 TRANSFER SPRING	2
6	V4014	T1 TRANSFER SPRING SUPPORT	2
7	V4036	T1 ROTOR DISK ASY	2
8	V3105	O-RING 215 (DISTRIBUTOR TUBE)	1
9	V3180	O-RING 337	1
10	V4016	T1 TRANSFER SEAL	6
11	V3031	T1 BODY SFT WTR REGEN	1
12	V4023	T1 TRANSFER DRIVE SHAFT ASY	1
13	V3287	O-RING 110	2
14	V4006-01	T1 TRANSFER DRIVE CAP ASY	1
15	V4011-01	T1 TRANSFER DRIVE GEAR ASY	1
16	V4012	T1 TRANSFER DRIVE GEAR AXLE	1
17	V4013	T1 TRANSFER REDUCTION GEAR	1
18	V3264	CWS200 BYPASS REDUCTION GEARAXLE	3
19	V3110	W100T DRIVE REDUCING GEAR 12X36	3
20	V3262-01	1.5" & 2" ALT/2BY REDUCGEARCVRASY	1
21	V3592	SCREW #8-1 PHPN T-25 SS	3
22	V4049	T1 COVER ASSEMBLY	1
NOT SHOWN	V4043	T1 TRANSFER MOTOR ASY	1
NOT SHOWN	V3151	W100T NUT 1 QC	1
NOT SHOWN	V4055*	TWIN TANK METER ASY	1
NOT SHOWN	V4017-01	T1 INTERCONNECT FITTING ASY	1
NOT SHOWN	D1400	1191 IN/OUT HEAD	1

⚠ WARNING

***THIS WATER METER SHOULD NOT BE USED AS THE PRIMARY MONITORING DEVICE FOR CRITICAL OR HEALTH EFFECT APPLICATIONS.**

Injector Cap, Injector Screen, Injector, Plug and O-Ring

Drawing No.	Order No.	Description	Quantity
1	V3176	INJECTOR CAP	1
2	V3152	O-RING 135	1
3	V3177-01	INJECTOR SCREEN CAGE	1
4	V3010-1Z	W100T INJECTOR ASY Z PLUG	1
5	V3010-1A	W100T INJECTOR ASY A BLACK	1
	V3010-1B	W100T INJECTOR ASY B BROWN	
	V3010-1C	W100T INJECTOR ASY C VIOLET	
	V3010-1D	W100T INJECTOR ASY D RED	
	V3010-1E	W100T INJECTOR ASY E WHITE	
	V3010-1F	W100T INJECTOR ASY F BLUE	
	V3010-1G	W100T INJECTOR ASY G YELLOW	
	V3010-1H	W100T INJECTOR ASY H GREEN	
	V3010-1I	W100T INJECTOR ASY I ORANGE	
	V3010-1J	W100T INJECTOR ASY J LIGHT BLUE	
	V3010-1K	W100T INJECTOR ASY K LIGHT GREEN	
Not Shown	V3170	O-RING 011	*
Not Shown	V3171	O-RING 013	*

* The injector plug and the injector each contain one 011 (lower) and 013 (upper) o-ring.

NOTICE

For upflow position, injector is located in the up hole and injector plug is in the other hole.
 Upflow option is not applicable to EA, EE or EI control valves.
 For a filter that only backwashes, injector plugs are located in both holes.

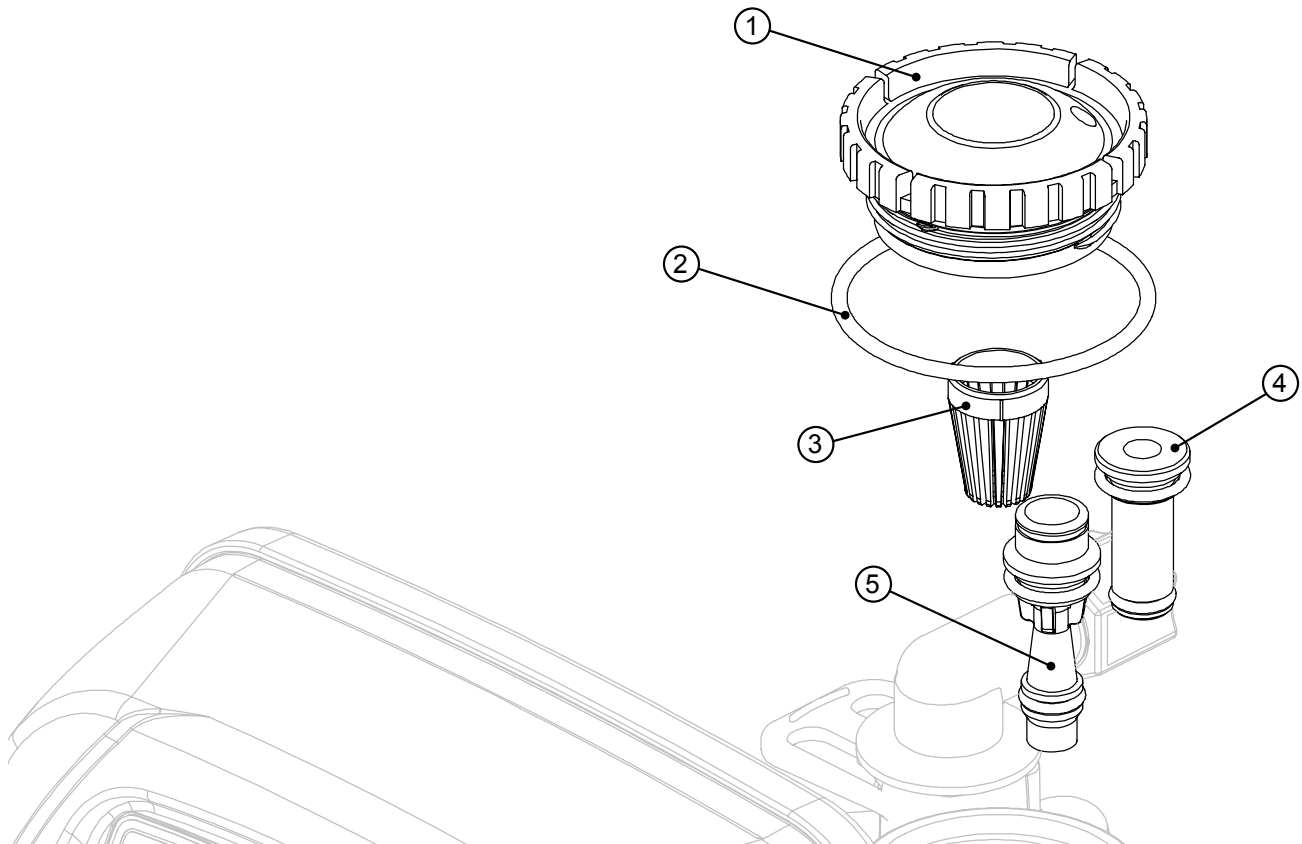

Injector Order Information

Injector Order Number	Injector Color	Typical Tank Diameter	
		Down	Up*
V3010-1A	Black	6"	8"
V3010-1B	Brown	7"	9"
V3010-1C	Violet	8"	10"
V3010-1D	Red	9"	12"
V3010-1E	White	10"	13"
V3010-1F	Blue	12"	14"
V3010-1G	Yellow	13"	16"
V3010-1H	Green	14"	18"
V3010-1I	Orange	16"	21"
V3010-1J	Light Blue	18"	
V3010-1K	Light Green	21"	

Actual tank size used may vary depending on the design and application of the system. Tank diameter is an approximation for the following:

1. Downflow softener using standard mesh synthetic cation exchange media regenerating with sodium chloride.
2. Upflow softener using standard mesh synthetic cation exchange media regenerating with sodium chloride, an inlet water pressure of 30 to 50 psi (2.1 to 3.4 bar) and water temperature of 60°F (15.6°C) water or warmer. Higher pressures or lower temperatures would need smaller injectors to avoid lifting the bed.

***Not applicable for EA, EE or EI control valves.**

BLACK, ORDER NO. V3010-1A
US Units

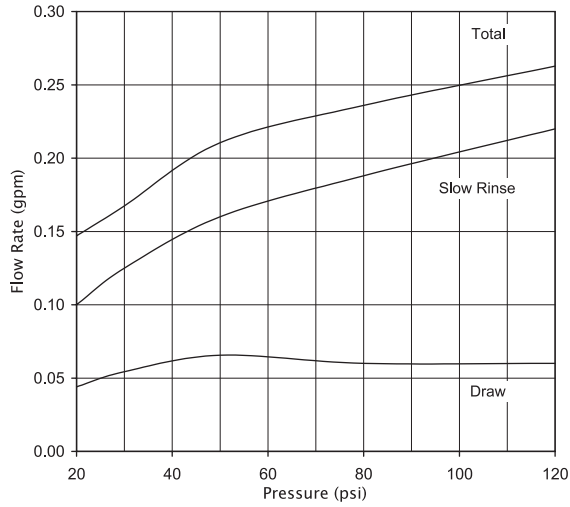

BROWN, ORDER NO. V3010-1B
US Units

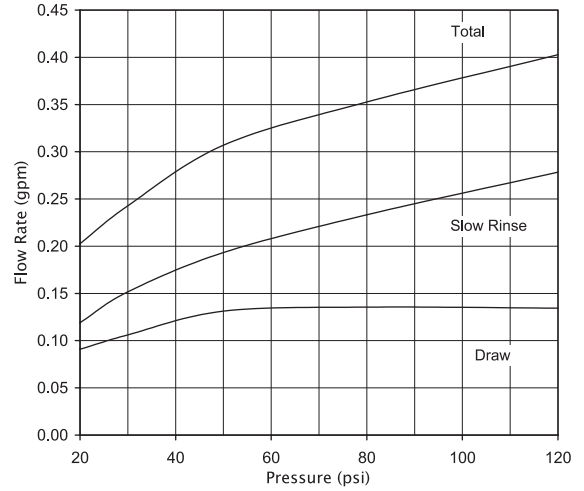

VIOLET, ORDER NO. V3010-1C
US Units

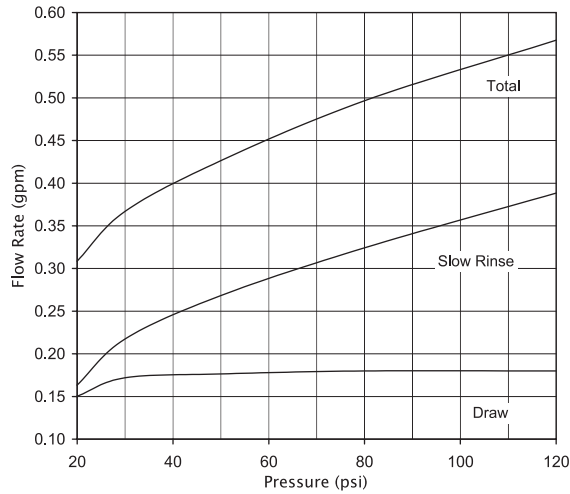

RED, ORDER NO. V3010-1D
US Units

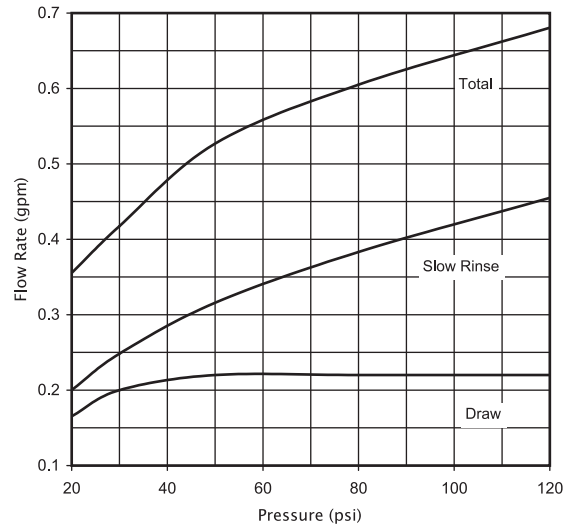

WHITE, ORDER NO. V3010-1E
US Units

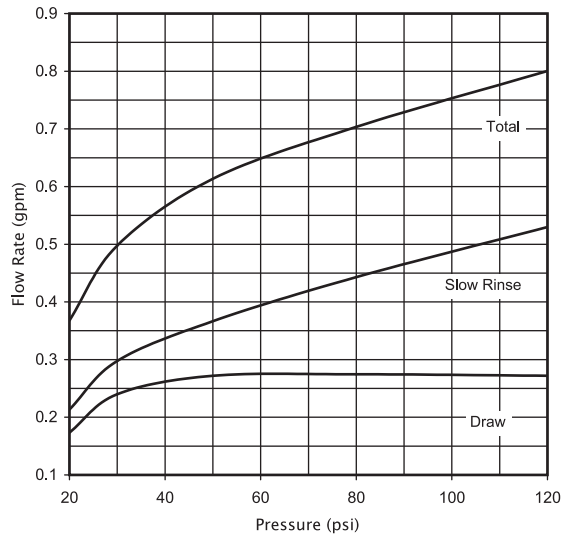

BLUE, ORDER NO. V3010-1F
US Units

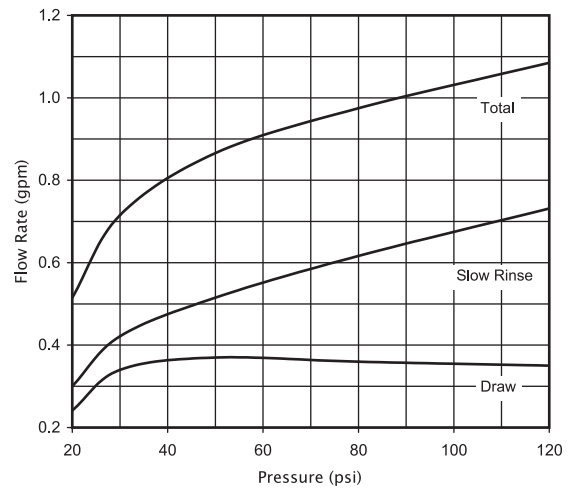

**YELLOW, ORDER NO. V3010-1G
US Units**

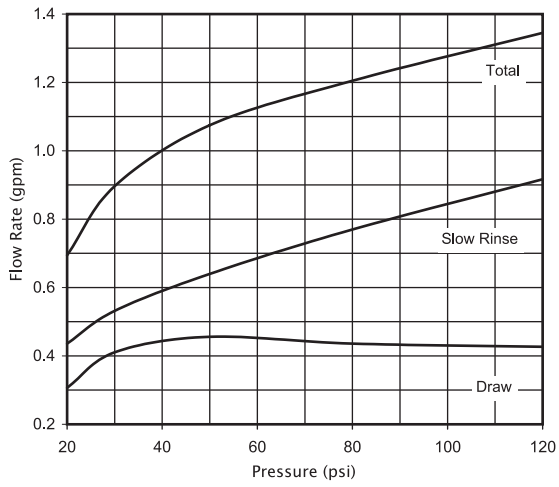

**GREEN, ORDER NO. V3010-1H
US Units**

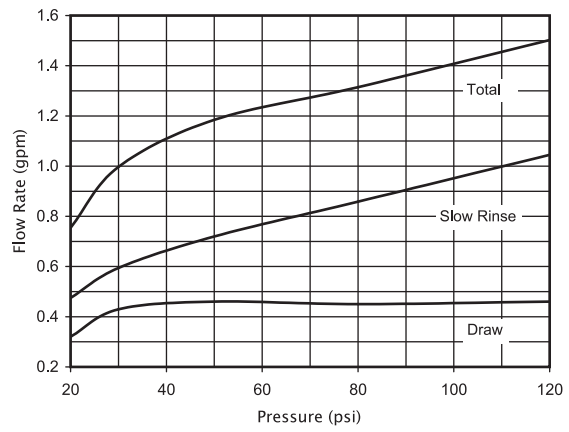

**ORANGE, ORDER NO. V3010-1I
US Units**

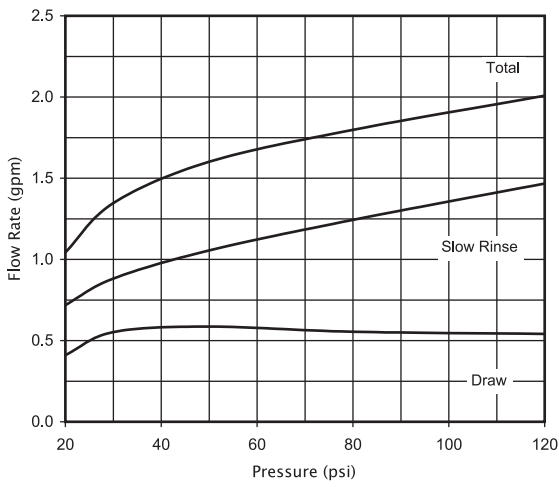

**LIGHT BLUE, ORDER NO. V3010-1J
US Units**

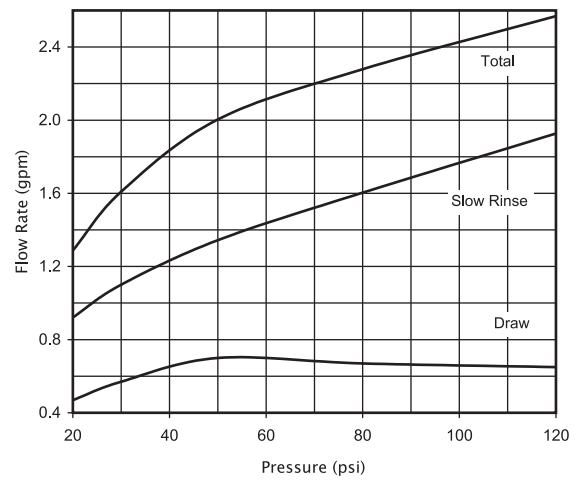

**LIGHT GREEN, ORDER NO. V3010-1K
US Units**

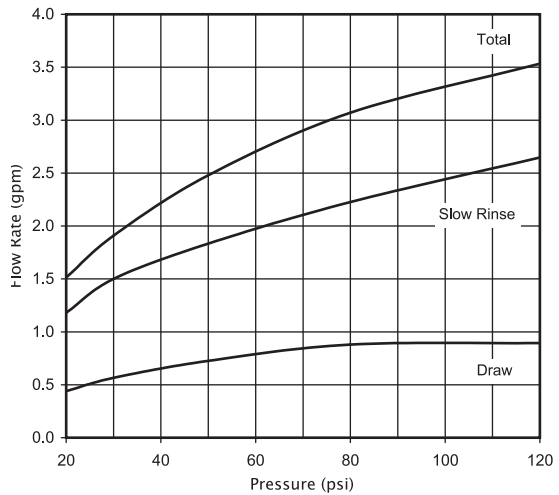

BLACK, ORDER NO. V3010-1A
Metric Units

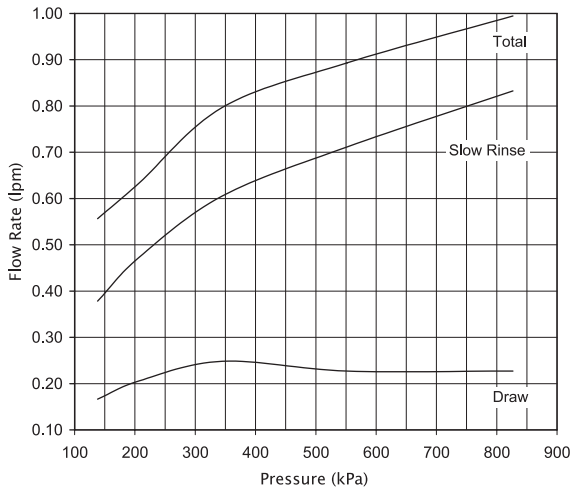

BROWN, ORDER NO. V3010-1B
Metric Units

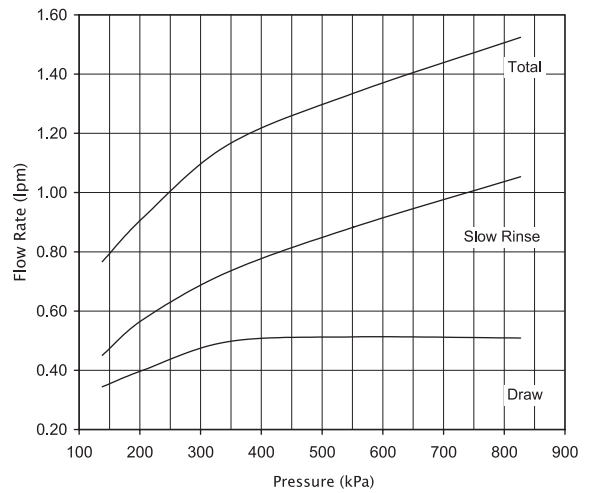

VIOLET, ORDER NO. V3010-1C
Metric Units

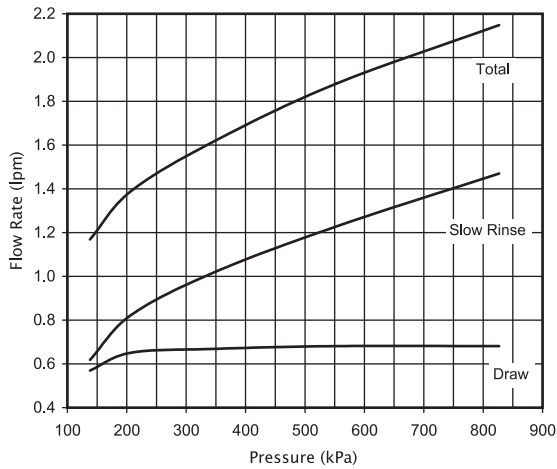

RED, ORDER NO. V3010-1D
Metric Units

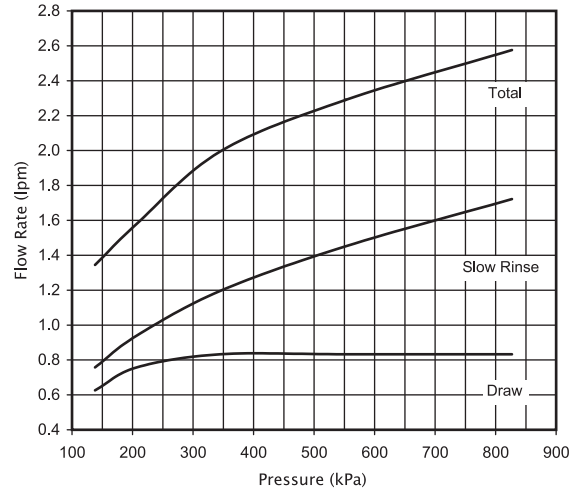

WHITE, ORDER NO. V3010-1E
Metric Units

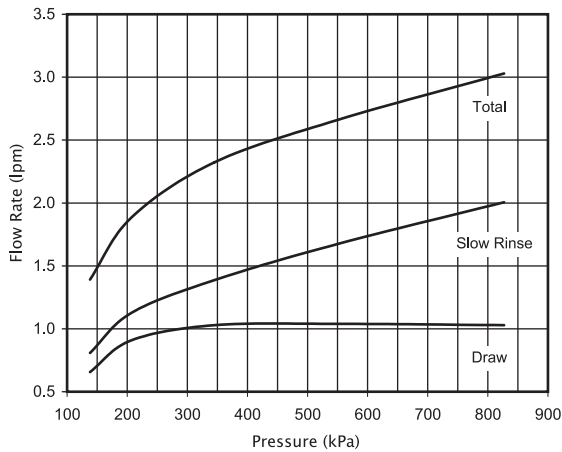

BLUE, ORDER NO. V3010-1F
Metric Units

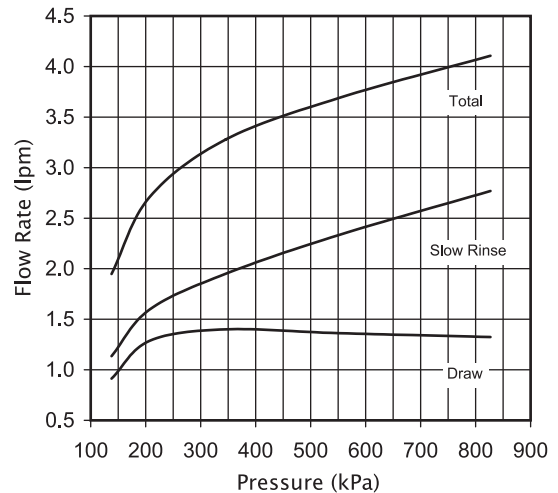

YELLOW, ORDER NO. V3010-1G
Metric Units

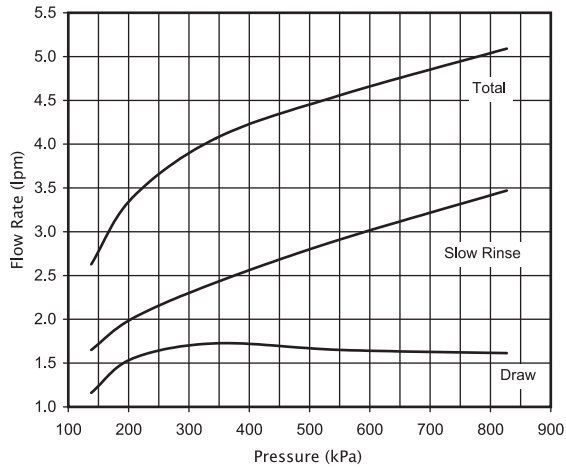

GREEN, ORDER NO. V3010-1H
Metric Units

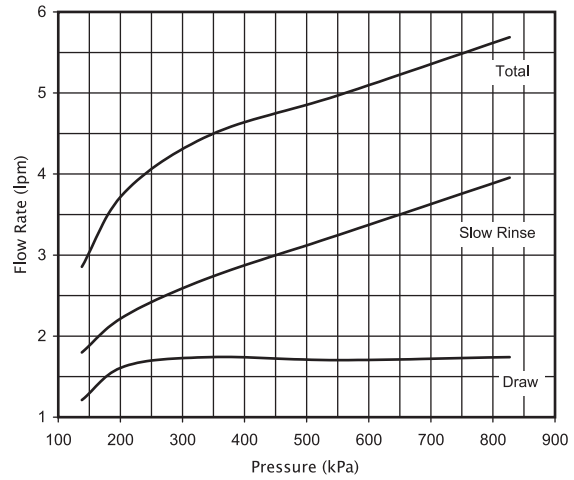

ORANGE, ORDER NO. V3010-1I
Metric Units

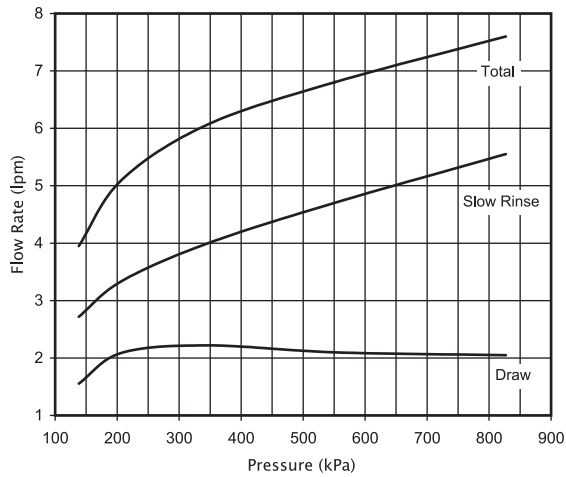

LIGHT BLUE, ORDER NO. V3010-1J
Metric Units

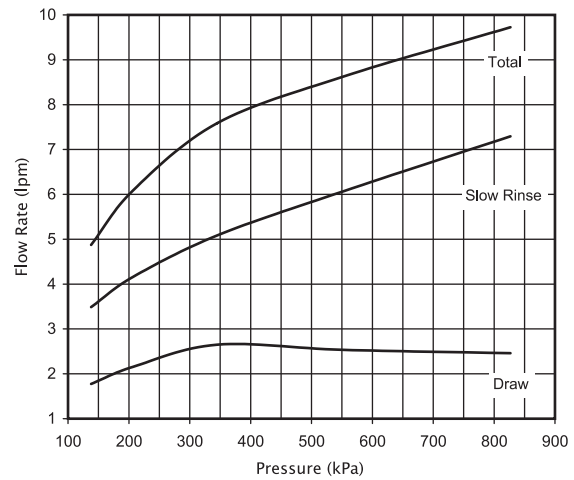

LIGHT GREEN, ORDER NO. V3010-1K
Metric Units

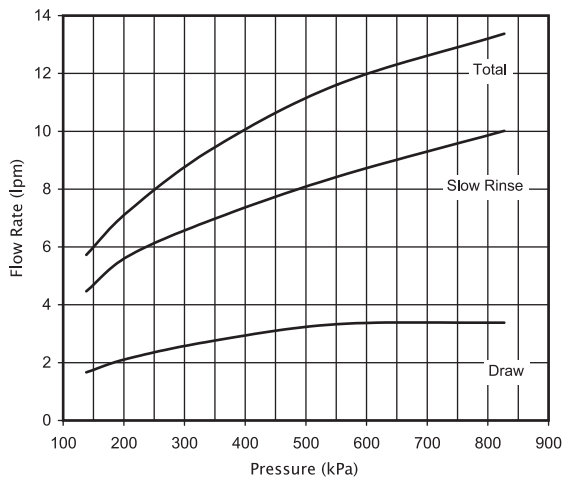

Refill Flow Control Assembly and Refill Port Plug

Drawing No.	Order No.	Description	Quantity
1	V3195-01	W100T Refill Port Plug Assy	This part is required for backwash only systems
2	H4615	Elbow Locking Clip	1
3	JCP-P-6	Polytube insert 3/8"	1
4	JCPG-6PBLK	Nut 3/8"	1
5	H4613	Elbow Cap 3/8"	1
6	V3163	O-ring 019	1
7	V3165-01*	W100T RFC Retainer Assy (0.5 gpm)	1
8	V3182	W100T RFC	1
9	V3330-01	W100T Brine Elbow Assy w/RFC 3/8"	1
Not Shown	V3552	W100T Brine Elbow Assy w/RFC 1/2"	Option
Not Shown	H4650	Elbow 1/2" with nut and insert	Option

*Assembly includes V3182 W100T (0.5 gpm) RFC.

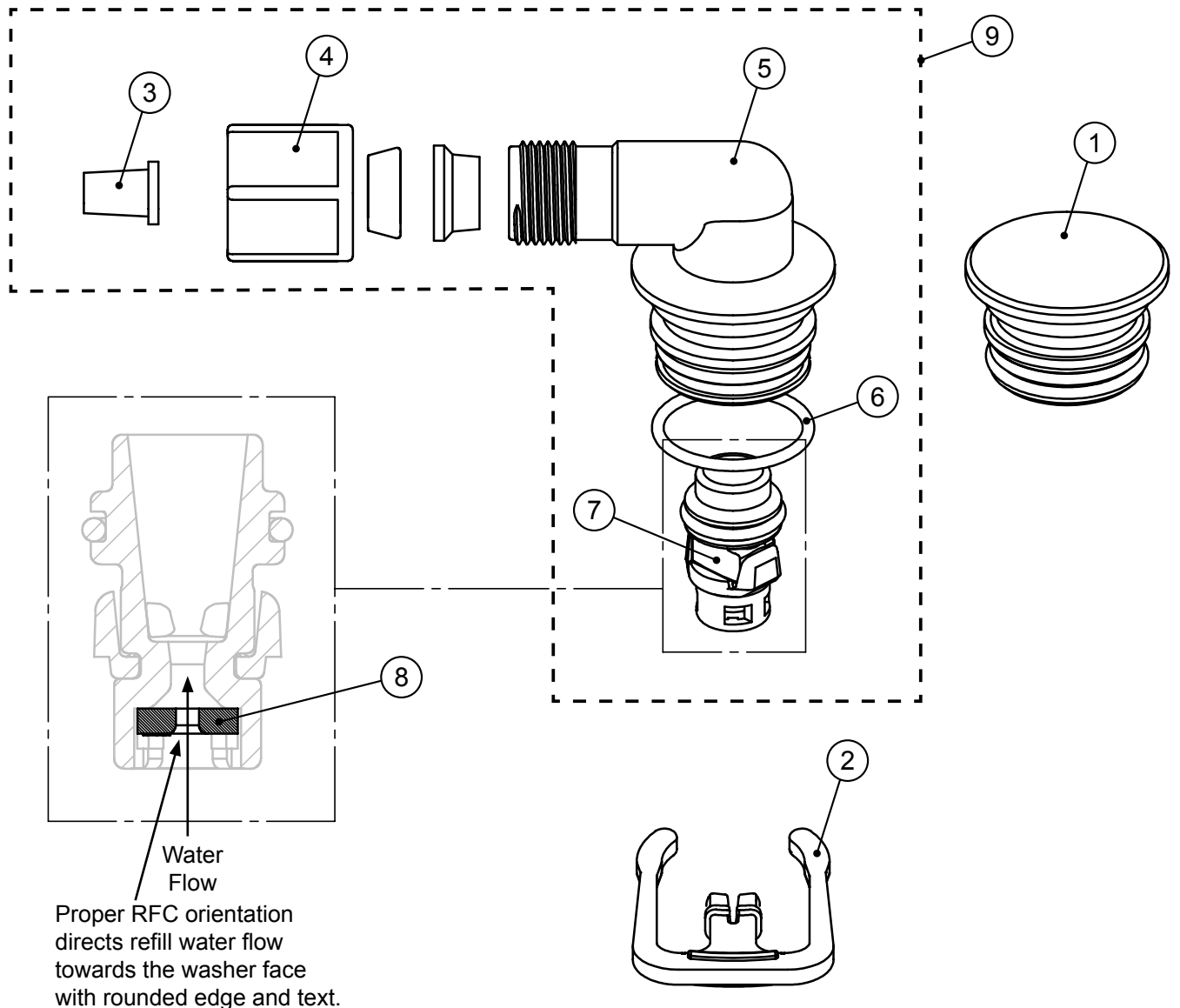

Drain Line – 3/4”

Drawing No.	Order No.	Description	Quantity
1	H4615	Elbow Locking Clip	1
2	PKP10TS8-BULK	Polytube insert 5/8	Option
3	V3192	W100T Nut 3/4 Drain Elbow	Option
4*	V3158-01	W100T Drain Elbow 3/4 Male	1
5	V3163	O-ring 019	1
6*	V3159-01	W100T DLFC Retainer ASY	1
7	V3162-007	W100T DLFC 0.7 gpm for 3/4	One DLFC must be used if 3/4 fitting is used
	V3162-010	W100T DLFC 1.0 gpm for 3/4	
	V3162-013	W100T DLFC 1.3 gpm for 3/4	
	V3162-017	W100T DLFC 1.7 gpm for 3/4	
	V3162-022	W100T DLFC 2.2 gpm for 3/4	
	V3162-027	W100T DLFC 2.7 gpm for 3/4	
	V3162-032	W100T DLFC 3.2 gpm for 3/4	
	V3162-042	W100T DLFC 4.2 gpm for 3/4	
	V3162-053	W100T DLFC 5.3 gpm for 3/4	
	V3162-065	W100T DLFC 6.5 gpm for 3/4	
	V3162-075	W100T DLFC 7.5 gpm for 3/4	
V3162-090	W100T DLFC 9.0 gpm for 3/4		
	V3162-100	W100T DLFC 10.0 gpm for 3/4	

*4 and 6 can be ordered as a complete assembly - V3331 W100T Drain Elbow and Retainer Asy

Valves are shipped without drain line flow control (DLFC) - install DLFC before using. Valves are shipped without 3/4 nut for drain elbow (polytube installation only) and 5/8" polytube insert (polytube installation only).

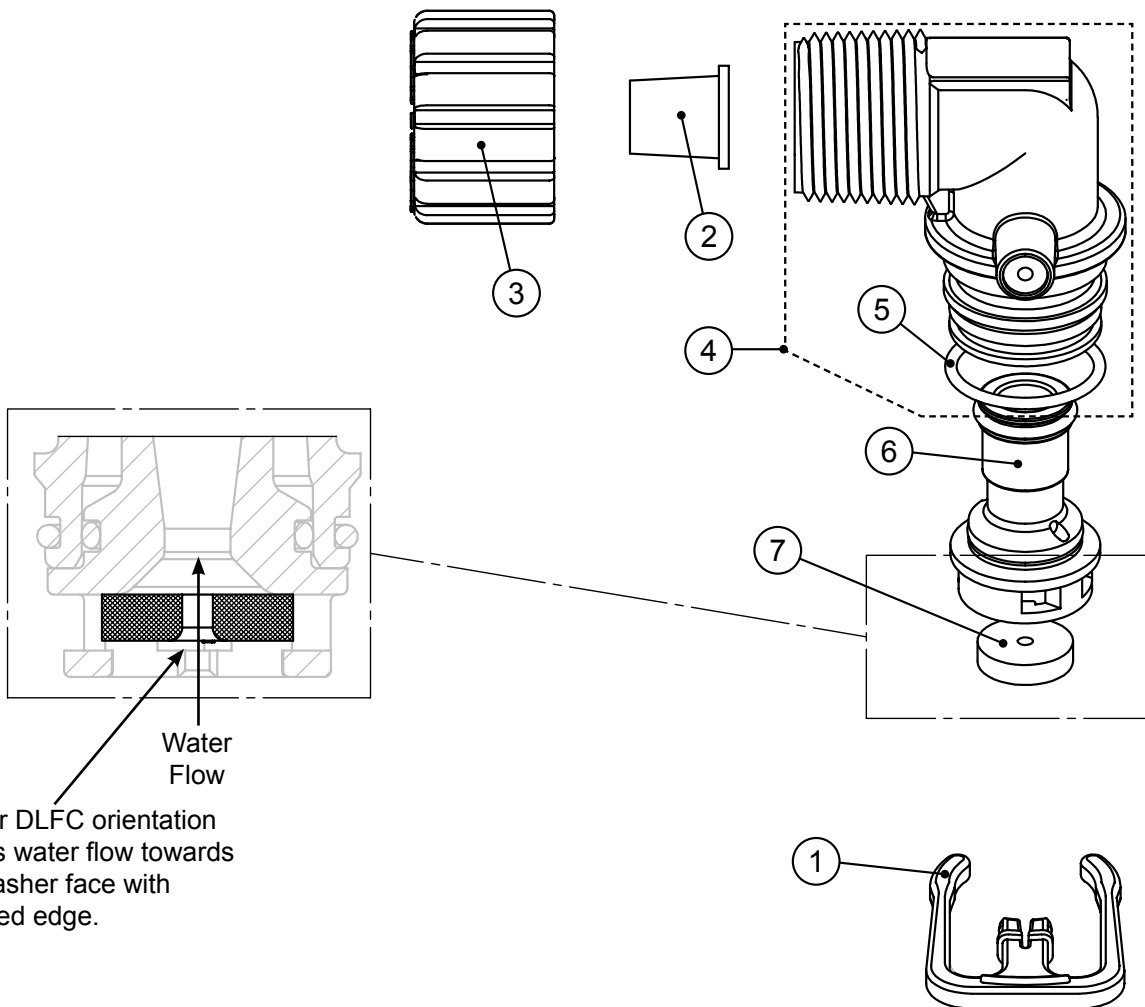

Drain Line - 1"

Drawing No.	Order No.	Description	Quantity
1	H4615	Elbow Locking Clip	1
2	V3008-02	W100T Drain FTG 1 Straight	1
3*	V3166	W100T Drain FTG Body 1	1
4*	V3167	W100T Drain FTG Adapter 1	1
5*	V3163	O-ring 019	1
6*	V3150	W100T Split Ring	1
7*	V3151	W100T Nut 1" QC	1
8*	V3105	O-ring 215	1
9	V3190-090	W100T DLFC 9.0 gpm for 1	One DLFC must be used if 1" fitting is used
	V3190-100	W100T DLFC 10.0 gpm for 1	
	V3190-110	W100T DLFC 11.0 gpm for 1	
	V3190-130	W100T DLFC 13.0 gpm for 1	
	V3190-150	W100T DLFC 15.0 gpm for 1	
	V3190-170	W100T DLFC 17.0 gpm for 1	
	V3190-200	W100T DLFC 20.0 gpm for 1	
	V3190-250	W100T DLFC 25.0 gpm for 1	

* Can be ordered as a set. Order number V3008-02, description: W100T Drain FTG 1 Straight.

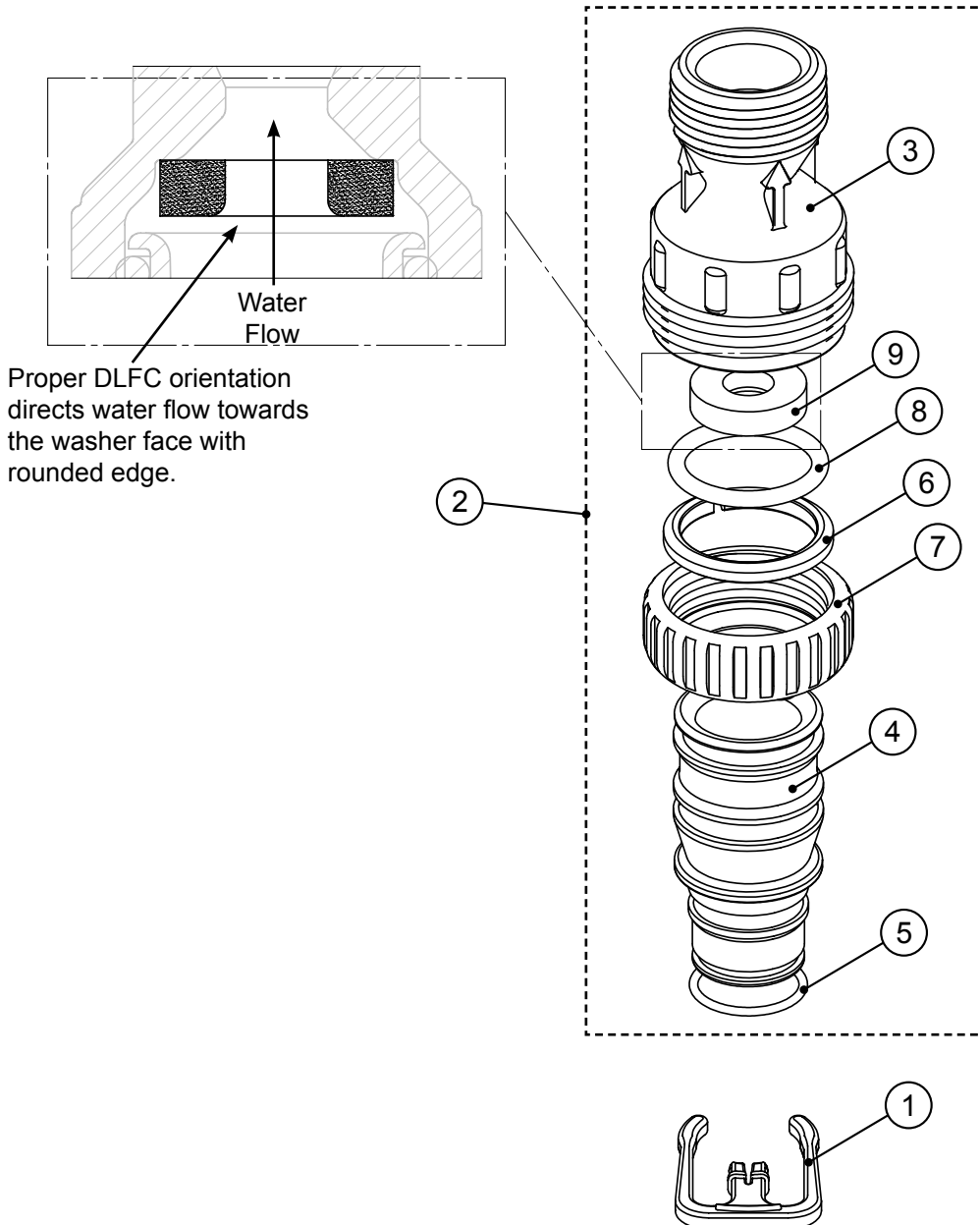

V4017-01 T1 Interconnect Fitting Assembly

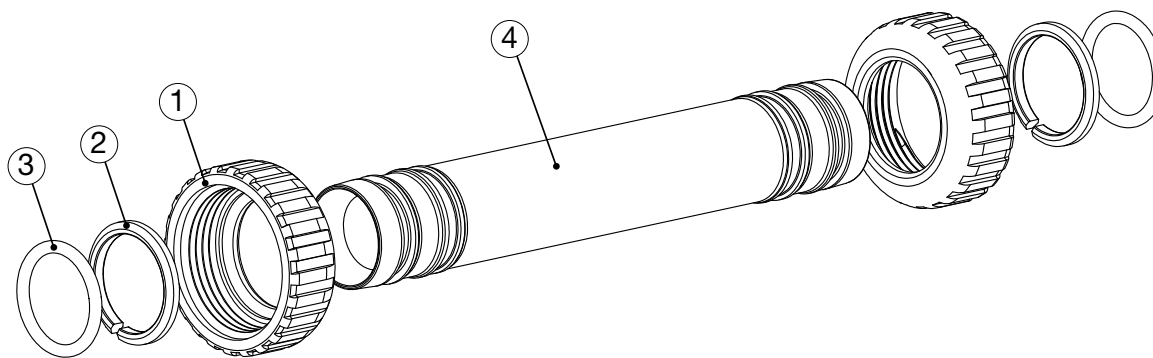

Drawing No.	Order No.	Description	Quantity
1	V3151	W100T Nut 1" Quick Connect	4
2	V3150	W100T Split Ring	4
3	V3105	O-Ring 215	4
4	V4017	T1 Interconnect Fitting	2

A. Fitting Installation Instructions:

- Installation fittings are designed to accommodate minor plumbing misalignments, but are not designed to support the weight of a system or the plumbing.
- Slide nut on first, then the split ring and o-ring.
- **Hand tighten the nut only.**

The V4017-01 can be used on tanks up to 10" in diameter.

If using 12" diameter tanks or larger V4052 PIPE PVC SCH 80 1-1/4X 20 (36 pieces per box) may be purchased and combined with two V3007-07 W100T FTG 1.25&1.5 PVC SLVNT ASY. The V4052 PIPE PVC SCH 80 1-1/4X 20 can be cut to the desired length.

D1400 1191 In/Out Head

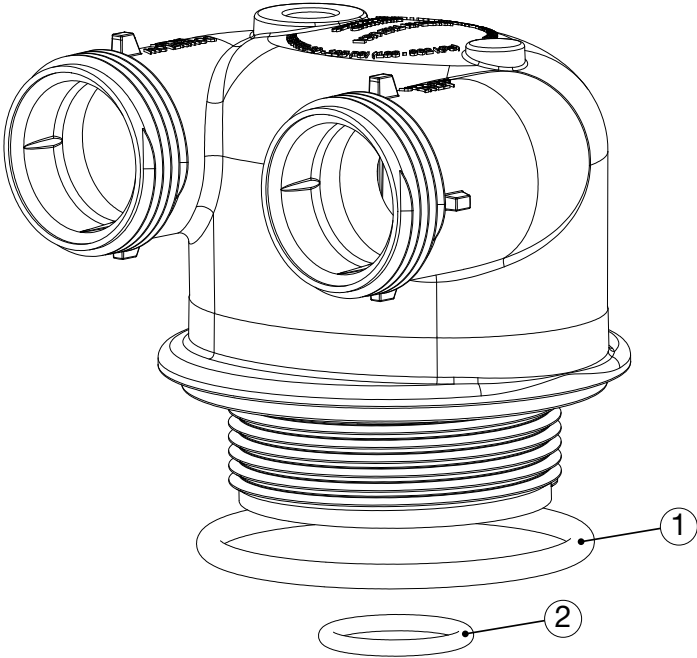

Drawing No.	Order No.	Description	Quantity
1	V3180	O-Ring 337	1
2	V3105	O-Ring 215 (Distributor Tube)	1

W100T Control Valve System Description

The W100T control valves consist of the following components:

1. Drive Assembly
2. Drive Cap Assembly, Main Piston and Regenerant Piston
3. Spacer Stack Assembly
4. Injector Cap, Screen, Injector Plug and Injector
5. Refill Flow Control Assembly or Refill Port Plug
6. Drain Line Flow Control and Fitting Assembly
7. Water Meter
8. Twin Transfer Valve

Drive Assembly

The drive assembly consists of the following parts:

- Drive Bracket
- Printed Circuit (PC) Board
- Motor
- Drive Gears
- Drive Gear Cover

The drive bracket holds the PC board, the motor, the drive gears and the drive gear cover in place.

The PC board receives and retains information, displays the information, determines when to regenerate and initiates regeneration. The display shows different types of information in the initial system set up (for softeners or filters), installer display settings, diagnostics, valve history or user display settings.

The PC board powers the motor. The PC board's two-prong jack connects wires to the direct current (DC) motor. The motor is held in place on the drive bracket by a spring-loaded clip and a small bulge in the plastic, which fits in one of the slots on the motor housing. The motor turns drive gears that drive the piston to cycle positions for backwashing, regeneration, rinsing, refill or service. The motor is fully reversible (turns both ways) and changes direction of rotation to change the direction of piston motion. The motor is easily replaced if necessary.

There are three drive gears held in place by the drive gear cover. All three drive gears are the same size. A reflective coating is applied to the gears. As the center drive gear turns a light shines on the coating and a light sensing diode determines if a light pulse was returned. The PC board counts the pulses and determines when to stop driving the motor.

Drive Cap Assembly, Main Piston and Regenerant Piston

The drive gears turn the main gear of the drive cap assembly, which moves the piston. The screw-driven, horizontally moving piston stops at specific positions to direct the flow of water to backwash, regenerate, rinse or refill. The PC board determines the position of the piston by counting pulses produced when the piston is moved. An optical sensor looking at one of the reduction drive gears generates these pulses. Each cycle position is defined by a number of pulses. The counter is zeroed each time the valve goes to the service position. The PC board finds the service position by noting the increase in current delivered to the motor when the mechanical stop at the service position is reached. This method of controlling piston position allows for greater flexibility and requires no switches or cams (U.S. Patent 6444127).

One of two main pistons is always used:

1. A 1.25" diameter downflow piston is used when the W100T control valve is used as a downflow softener, regenerating filter or non-regenerating filter.
2. A 1.25" diameter upflow piston is used when the W100T control valve is used as an upflow softener. Upflow option not applicable for EA, EE or EI control valves.

If the control valve is used as a softener or a regenerating filter, a regenerant piston must be attached to the main piston. If the control valve is to be used on a system that does not require a regenerant to be added, the regenerant piston must be removed.

Spacer Stack Assembly

The spacer stack assembly provides the necessary flow passage for water during the different cycles. The all-plastic spacer stack assembly (U.S. Patent 6402944) is a one-piece design which allows the stack to be removed using your fingers.

The exterior of the stack is sealed against the body bore with self lubricating EPDM o-rings, while the interior surface is sealed against the piston using slippery self cleaning directional (one-way) silicone lip seals. The lip seals are clear in color and have a special slippery coating so that the piston does not need to be lubricated.

Injector Cap, Screen, Injector Plug and Injector

The screen, injector and/or injector plug(s) are installed under the injector cap in an easy to access location on top of the valve. The injector cap contains four slots so no water accumulates in the cap. The injector cap is designed to be hand tightened.

Under the injector cap there is an easy to clean removable screen to prevent fouling of the injector. There are two holes under the injector cap labeled "DN" and "UP". The holes will be filled with a plug or an injector.

The plug (Order # V3010-1Z) prevents water from traveling a certain pathway. The injector lets water pass through the pathway. The self-priming injector increases the velocity of the water, creating a zone of negative pressure that draws in the concentrated liquid regenerant, such as sodium chloride (brine), potassium permanganate, etc. The regenerant blends with the stream of water, which passes through the media to regenerate the bed.

The injector provides a consistent regenerant/water mixture ratio over the entire operating pressure range of the control valve. The injector provides good performance in a variety of applications, which may involve elevated drain lines and long regenerant draw lengths. Injectors are chosen by knowing the type, amount, and regenerant flow rate for a particular type of media. Guidelines can be found in the media manufacturer's literature. The color coded injectors give different regenerant draw, slow rinse and total flow rates over the pressure range. See injector graphs (pages 25-28) for total, slow rinse and draw flow rates.

The control valve has been manufactured to be one of the following:

- regeneration downflow W100T (for softeners or regenerating filters install injector in DN location, plug in UP location)
- regeneration upflow W100T (upflow option is for softeners only, which are not EA, EE or EI control valves. Install injector in UP location, plug in other hole location)
- no regenerant W100T (both the DN and UP holes have injector plugs installed) and plug installed for the refill elbow

NOTICE

It is okay to field convert valves from upflow to downflow and vice versa with the W100T valve as long as software supports upflow brine.

Refill Flow Control Assembly or Refill Port Plug

The refill flow control assembly consists of a refill flow elbow, refill flow control retainer assembly, refill flow control, polytube insert and nut assembly. The refill flow control retainer fits in the refill elbow. The refill flow control retainer houses the refill flow control which controls the flow rate when the regenerant tank is being refilled. The refill flow control is a flexible washer-like part with a small orifice and a precision molded contour that delivers a steady 0.5 gpm regenerant tank refill rate at varying inlet pressures. Refill is accomplished with treated water.

The refill flow control assembly is installed in an easy to access refill elbow located on top of the control valve. The refill flow control assembly is attached to the control valve with a locking clip. The locking clip allows the elbow to rotate 270 degrees so the outlet can be orientated towards the regenerant tank.

The control valve has a standard refill elbow to which a 3/8" flexible tube can be connected. An optional elbow can be ordered which accommodates a 1/2" flexible tube for a high regenerant draw rate situation. Both elbows use the same refill flow control and retainer.

If the control valve is to be used as a non-regenerant filter control valve, the refill elbow is removed and replaced with a refill port plug P/N V3195-01.

Drain Line Flow Control and Fitting Assembly

The drain line flow control assembly includes a drain line flow control and a fitting. The drain line flow control allows proper media bed expansion by regulating the flow rate to the drain. The drain line flow control is a flexible washer-like part with an orifice and a precision molded contour. The flow rates are within $\pm 10\%$ over the pressure range of 20 psi to 125 psi (1.4 bar to 8.6 bar). See table for flow rate information.

A. Drain Line Flow Control and Fitting Assembly Information

Drain Line Fitting	Drain Line Flow Control Order No.	Number on Drain Line Flow Control	Backwash Flow Rate (gpm)	Backwash Flow Rate (lpm)
3/4"	V3162-007	007	0.7	2.6
3/4"	V3162-010	010	1.0	3.8
3/4"	V3162-013	013	1.3	4.9
3/4"	V3162-017	017	1.7	6.4
3/4"	V3162-022	022	2.2	8.3
3/4"	V3162-027	027	2.7	10.2
3/4"	V3162-032	032	3.2	12.1
3/4"	V3162-042	042	4.2	15.9
3/4"	V3162-053	053	5.3	20.1
3/4"	V3162-065	065	6.5	24.6
3/4"	V3162-075	075	7.5	28.4
3/4"	V3162-090	090	9.0	34.1
3/4"	V3162-100	100	10.0	37.9
1"	V3190-090	090	9.0	34.1
1"	V3190-100	100	10.0	37.9
1"	V3190-110	110	11	41.6
1"	V3190-130	130	13	49.2
1"	V3190-150	150	15	56.8
1"	V3190-170	170	17	64.3
1"	V3190-200	200	20	75.7
1"	V3190-250	250	25	94.6

1. The drain line flow control and fitting are located on top of the control valve and replaceable without the use of special tools.
2. The drain line flow control can be installed in the standard 3/4" drain line elbow, which accommodates 5/8" polytube or 3/4" NPT drain line connections. The optional nut and polytube insert for the 3/4" drain line elbow is designed for use with flexible polytube only. The 3/4" drain line elbow can be rotated 180 degrees so the outlet can be orientated to the nearest drain. The same retainer is used for all drain line flow controls for the 3/4" fitting. Drain line flow controls designed for the 3/4" fitting are available for flow rates ranging from 0.7 to 10 gpm (2.6 to 37.9 lpm).
3. An optional 1" straight drain line fitting is available to accommodate drain line flow rates ranging from 9 to 25 gpm (34.1 to 94.6 lpm). This fitting is straight but still connects to the control valve using the same locking clip. The drain line flow control is located between two fitted parts (i.e. the fitting acts as the retainer). The nut is unscrewed to access the drain line flow control.

Service Instructions

Drive Assembly

1. Remove the valve cover to access the drive assembly.
2. Disconnect the power source plug (black wire) from the PC board prior to disconnecting the motor or water meter plugs from the PC board. The power source plug connects to the four-pin jack. The motor plug connects to the two-pin jack on the left-hand side of the PC board. The water meter plug (gray wire) connects to the three-pin jack on the far right-hand side of the PC board.
3. The PC board can be removed separately from the drive bracket but it is not recommended. Do not attempt to remove the display panel from the PC board. Handle the board by the edges. To remove the PC board from the drive bracket, unplug the power, water meter and motor plugs from the PC board. Lift the middle latch along the top of the drive bracket while pulling outward on the top of the PC board. The drive bracket has two plastic pins that fit into the holes on the lower edge of the PC board. Once the PC board is tilted about 45° from the drive bracket it can be lifted off of these pins. To reinstall the PC board, position the lower edge of the PC board so that the holes in the PC board line up with the plastic pins. Push the top of the PC board towards the valve until it snaps under the middle latch, weave the power and water meter wires into the holders and reconnect the motor, water meter and power plugs.
4. The drive bracket must be removed to access the drive cap assembly and pistons or the drive gear cover. It is not necessary to remove the PC board from the drive bracket to remove the drive bracket. To remove the drive bracket start by removing the plugs for the power source and the water meter. Unweave the wires from the side holders. Two tabs on the top of the drive back plate hold the drive bracket in place. Simultaneously lift the two tabs and gently ease the top of the drive bracket forward. The lower edge of the drive bracket has two notches that rest on the drive back plate. Lift up and outward on the drive bracket to disengage the notches.
5. To reassemble, seat the bottom of the drive bracket so the notches are engaged at the bottom of the drive back plate. Push the top of the drive bracket toward the two latches. The drive bracket may have to be lifted slightly to let the threaded piston rod pass through the hole in the drive bracket. Maintain a slight engaging force on top of the drive bracket while deflecting the bracket slightly to the left by pressing on the side of the upper right corner. This helps the drive gears mesh with the drive cap assembly. The drive bracket is properly seated when it snaps under the latches on the drive back plate. If resistance is felt before latching, then notches are not fully engaged, the piston rod is not in hole, the wires are jammed between the drive bracket and drive back plate, or the gear is not engaging the drive cap assembly.
6. To inspect the drive gears, the drive gear cover needs to be removed. Before trying to remove the gear cover, the drive bracket must be removed from the drive back plate. (Refer to the instructions above regarding removing the drive bracket from the drive back plate. The drive gear cover can be removed from the drive bracket without removing the motor or the PC board.) The drive gear cover is held in place on the drive bracket by three clips. The largest of the three clips is always orientated to the bottom of the drive bracket. With the PC board facing up, push in and down on the large clip on the drive gear cover. Handle the cover and the gears carefully so that the gears do not fall off the pegs in the cover.
7. Replace broken or damaged drive gears. Do not lubricate any of the gears. Avoid getting any foreign matter on the reflective coating because dirt or oils may interfere with pulse counting.
8. The drive gear cover only fits on one way, with the large clip orientated towards the bottom. If all three clips are outside of the gear shroud on the drive bracket the drive gear cover slips easily into place.
9. The drive bracket does not need to be removed from the drive plate if the motor needs to be removed. To remove the motor, disconnect the power and motor plugs from the jacks on the PC board. Move the spring clip loop to the right and hold. Rotate the motor at least a ¼ turn in either direction so the wires are vertical (up & down) before gently pulling on the wire connectors to remove the motor. Pulling directly on the wires without rotating the motor may break the wires off the motor.
10. Replace the motor if necessary. Do not lubricate the motor or the gears. To reinstall the motor, move the spring clip loop to the right and hold. Gently turn the motor while inserting so that the gear on the motor meshes with the gears under the drive gear cover. Release the spring clip loop and continue to rotate the motor until the wires are horizontal and the motor housing engages the small plastic bulge inside the drive bracket motor retainer. Reconnect the motor plug to the two-pronged jack on the lower left side of the PC board. If the motor will not easily engage with the drive gears when reinstalling, lift and slightly rotate the motor before reinserting. Reconnect the power plug.
11. Replace the valve cover. After completing any valve maintenance involving the drive assembly or the drive cap assembly and pistons unplug power source jack from the printed circuit board (black wire) and plug back in or press and hold NEXT and REGEN buttons for 3 seconds. This resets the electronics and establishes the service piston position. The display should flash all wording, then flash the software version and then reset the valve to the service position.

Drive Cap Assembly, Main Piston and Regenerant Piston

1. The drive assembly must be removed to access the drive cap assembly. The drive cap assembly must be removed to access the piston(s). The drive cap assembly is threaded into the control valve body and seals with an o-ring. To remove the drive cap assembly use the special plastic wrench or insert a ¼" to ½" flat blade screwdriver into one of the slots around the top 2" of the drive cap assembly so it engages the notches molded into the drive back plate around the top 2" of the piston cavity. The notches are visible through the holes. Lever the screwdriver so the drive cap assembly turns counter clockwise. Once loosened unscrew the drive cap assembly by hand and pull straight out.
2. The drive cap assembly contains the drive cap, the main drive gear, drive cap spline, piston rod and various other parts that should not be disassembled in the field. The only replaceable part on the drive cap assembly is the o-ring. Attached to the drive cap assembly is the main piston (downflow or upflow) and if a regenerant is used, a regenerant piston. Upflow is not applicable to EA, EE or EI control valves.
3. The regenerant piston (the small diameter one behind the main piston) is removed from the main piston by pressing sideways and unsnapping it from its latch. Chemically clean in dilute sodium bisulfite or vinegar, or replace the regenerant piston if needed. To remove the main piston fully extend the piston rod and then unsnap the main piston from its latch by pressing on the side with the number. Chemically clean in dilute sodium bisulfite or vinegar, or replace the main piston.
4. Reattach the main piston to the drive cap assembly. Reattach the regenerant piston (if needed) to the main piston. Reinsert the drive cap assembly and piston into the spacer stack assembly and hand tighten the drive cap assembly. Continue to tighten the drive cap assembly using a screwdriver as a ratchet until the black o-ring on the spacer stack assembly is no longer visible through the drain port. Excessive force can break the notches molded into the drive back plate. Make certain that the main drive gear still turns freely. The exact position of the piston is not important as long as the main drive gear turns freely.

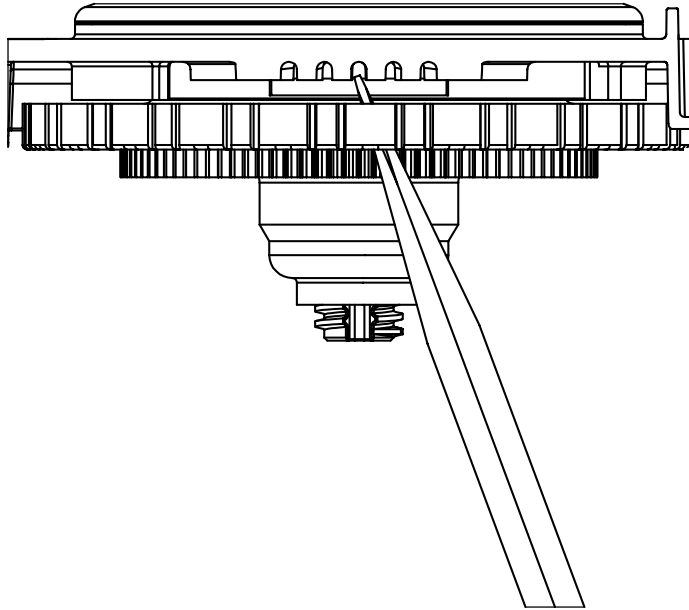

5. Reattach the drive assembly to the control valve and connect all plugs. After completing any valve maintenance involving the drive assembly or the drive cap assembly and pistons unplug power source jack from the printed circuit board (black wire) and plug back in or press and hold NEXT and REGEN buttons for 3 seconds. This resets the electronics and establishes the service piston position. The display should flash all wording, then flash the software version and then reset the valve to the service position.

Spacer Stack Assembly

1. To access the spacer stack assembly remove the drive assembly, drive cap assembly and piston. The spacer stack assembly can be removed easily without tools by using thumb and forefinger. Inspect the black o-rings and clear lip seals for wear or damage. Replace the entire stack if necessary. Do not disassemble the stack.
2. The spacer stack assembly may be chemically cleaned (dilute sodium bisulfite or vinegar) or wiped with a soft cloth.
3. The spacer stack assembly can be pushed in to the control valve body bore by hand. Since the spacer stack assembly can be compressed it is easier to use a blunt object (5/8" to 1-1/8" in diameter) to push the center of the assembly into the control valve body. The assembly is properly seated when at least four threads are exposed (approximately 5/8"). Do not force the spacer stack assembly in. The control valve body bore interior can be lubricated with silicone to allow for easy insertion of the entire stack.
4. Reattach the drive cap assembly and piston(s) and the drive assembly.
5. After completing any valve maintenance involving the drive assembly or the drive cap assembly and pistons unplug power source jack from the printed circuit board (black wire) and plug back in or press and hold NEXT and REGEN buttons for 3 seconds. This resets the electronics and establishes the service piston position. The display should flash all wording, then flash the software version and then reset the valve to the service position.

Injector Cap, Screen, Injector Plug and Injector

1. Unscrew the injector cap and lift off. Loosen cap with special plastic wrench or pliers if necessary. Attached to the injector cap is a screen. Remove the screen and clean if fouled.
2. The plug and/or injector can be pried out with a small screwdriver. The plug can be wiped clean. If the plug leaks replace the entire plug. The injector consists of a throat and a nozzle. Chemically clean the injector with vinegar or sodium bisulfite. The holes can be blown out with air. Both pieces have small diameter holes that control the flow rates of water to insure that the proper concentration of regenerant is used. Sharp objects, which can score the plastic, should not be used to clean the injector. Scoring the injector or increasing the diameter of the hole could change the operating parameters of the injector.

NOTICE

Two holes are labeled DN and UP. Check for compliance. Refer to Valve Body Compliance Table at the beginning of this manual.

3. Push the plug(s) and/or injectors firmly in place, replace the screen and hand tighten the injector cap.

Refill Flow Control Assembly or Refill Port Plug

1. To clean or replace the refill flow control, pull out the elbow-locking clip and then pull straight up on the elbow. Replace the elbow locking clip in the slot so that it is not misplaced. Twist to remove the white flow control retainer. The flow control can be removed by prying upward through the side slots of the retainer with a small flat blade screwdriver.
2. Chemically clean the flow control or the white flow control retainer using dilute sodium bisulfite or vinegar. Do not use a wire brush. If necessary, replace the flow control, o-ring on the flow control retainer, or the o-ring on the elbow.
3. Reseat the flow control so the rounded end is visible in the flow control. Reseat the white flow control retainer by pushing the retainer into the elbow until the o-ring seats. Remove locking clip, push down on elbow to reseal and insert locking clip.
4. Do not use Vaseline, oils, or other unacceptable lubricants on o-rings. A silicone lubricant may be used on the o-ring on the elbow or the white retainer.

Water Meter

NOTICE

Do not use a wire brush to clean the turbine. Wipe with a clean cloth or chemically clean in dilute sodium bisulfite or vinegar. The turbine can be immersed in the chemical. Do not immerse electronics. If the turbine is scored or damaged or the bearings on the turbine are worn, replace the turbine.

Do not lubricate the turbine shaft. The turbine shaft bearings are prelubricated. Do not use Vaseline, oils, or other unacceptable lubricants on the o-ring. A silicone lubricant may be used on the black o-ring.

1. The water meter assembly is connected to the PC board by a wire. If the entire water meter assembly is to be replaced, remove the control valve cover and disconnect the power source and water meter plugs from the PC board. Unlatch the drive assembly and lean it forward. Unthread the water meter wire from the side of the drive assembly and through the drive back plate. To reinstall, rethread the water meter wire through the drive back plate and the side of the drive assembly. Reattach the drive assembly and the water meter and power plugs.

NOTICE

THIS WATER METER SHOULD NOT BE USED AS THE PRIMARY MONITORING DEVICE FOR CRITICAL OR HEALTH EFFECT APPLICATIONS.

- Operating Pressures:
20 PSI Minimum / 125 PSI Maximum
 - Operating temperatures:
40°F MINIMUM / 110°F MAXIMUM.
2. If no water meter wire is visible, then a plug is installed, not a water meter.
3. The water meter wire does not need to be removed from the PC board if the water meter is only being inspected and cleaned. To remove the water meter assembly, unscrew the meter cap on the left side of the control valve. Pliers may be used to unscrew the nut if necessary.
4. With the nut removed, a slot at the top of the water meter is visible. Twist a flat blade screwdriver in the slot between the control valve body and the meter. When the meter is part way out it is easy to remove the water meter from the housing. Once the water meter is removed from the control valve body, gently pull forward on the turbine to remove it from the shaft.
5. Reinsert the water meter into the side slot. Do not use a pipe wrench to tighten nut. Hand tighten the nut.

Servicing Transfer Cap Assemblies

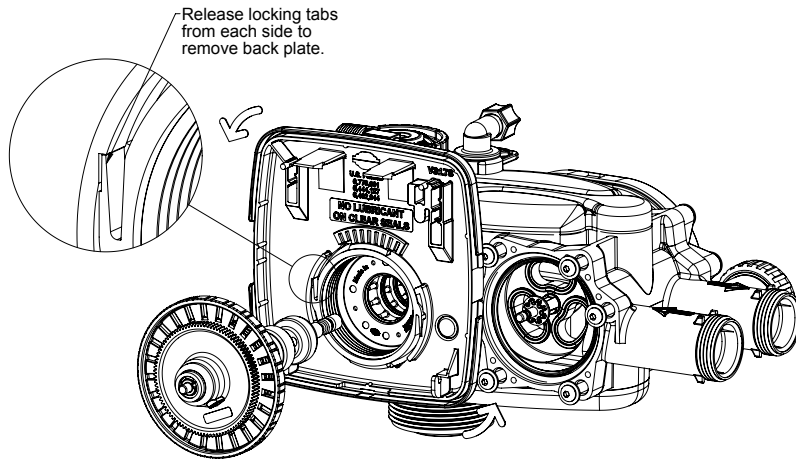

1. The control valves backplate must be removed first to allow access to removing the transfer cap assembly.
2. Hold slight downward pressure on the top left corner of the backplate while using a thin flat screwdriver or knife blade to push in on the locking tabs, this will release the backplate and it will twist to the left off of the valve body. For removal of the drive motor side you will need to remove the drive cover assembly to access the motorized drive. The drive motor can be removed by pressing the spring clip loop to the right then rotate the motor a 1/4 turn and pull outward to remove the motor from the reducing gear cover assembly. Remove the three Phillips head stainless steel screws that retain the reducing gear cover to the drive cap. Once the cover is removed you have access to the reducing drive gears simply slide them off of the gear axes with your fingers to inspect / check them there are 3 small black gears with foil decals and 1 larger black reducing gear. Remove the large white drive gear from the stainless steel drive shaft. To remove the large white transfer drive gear firmly grab the outside edge of the gear with your fingers and pull it outward away from the control valve assembly. Now you can use a 5/32" or 4mm allen wrench to remove the 1/4-20 screws that retain the transfer drive cap assemblies on both sides of the valve.

3. Once the screws are removed from retaining the inlet side transfer valve cap and the outlet drive motor transfer cap from the control valve the cap will spring out away from the valve body. At this point the transfer discs may be removed by pulling the discs outward off of the shaft away from the valve body with your hand. With the disc out you can inspect the flat surface area to be sure it's clean and smooth free of any debris or scratches. Note that the disc is keyed to the drive shaft so that it will only assemble in one orientation. The transfer discs may be chemically cleaned with a dilute sodium bisulfate solution, vinegar or just wiped with a soft clean cloth.

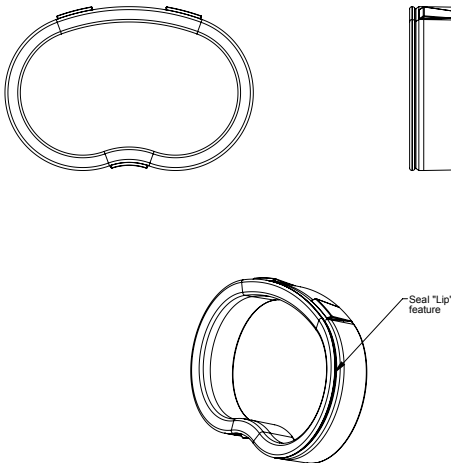

4. To remove seals gently pull out on the outer lip of the seal to lift the seal out from its cavity being careful not to damage the face surface of the seal. To reassemble re-seat seals into the seal cavity of the control valve body being sure that the lip of the seal is facing outward. With seals in place put a thin film of Dow #7 on the tops of the seals and the flat surface of the discs. Prior to reinstalling the discs the drive shaft should be removed and the O-rings cleaned, inspected and lubricated with Dow #7. The shaft can then be installed into the disc prior to installation. With the outlet disc assembled to the shaft the orientation of the shaft to inlet disc can be assured by installing the set with the through hole on the outlet disc at the 6 o'clock position.

The easiest thing would be to remove both disc drives and assemble the outlet side first. Then each disc could be fitted on the shaft individually. At this point the transfer valve cap assemblies can be reinstalled.

Servicing Transfer Cap Assemblies (continued)

NOTICE

That both transfer caps only mount in one orientation. Prior to installation of cap assembly be sure to check that the stainless steel spring and the plastic spring support is in place attached to the inside of the cap assembly. Next you can wipe the outside edge of the O-ring on the cap and the inside mating area of the valve with a clean cloth & re-apply a thin layer of silicone lubricant like Dow #7.

CAUTION

BE SURE NOT TO USE ANYTHING HYDROCARBON BASED SUCH AS VASELINE OR PETROLEUM JELLY TO LUBRICATE PLASTIC COMPONENTS OR O-RINGS AS THEY WILL BE DAMAGED BY THE HYDROCARBONS AND POTENTIALLY CAUSE FAILURES THAT CAN RESULT WITH LEAKS.

1. Noting the one possible orientation of the transfer drive cap, use one hand to press in and support the transfer drive cap while using the opposing hand to start two screws in, one on the top and one opposing it on the bottom. Tighten the screws in evenly so the cap seats the O-ring without getting pinched or damaged. Screws should only be hand tightened with a 5/32" or 4mm allen wrench, **DO NOT OVER TIGHTEN SCREWS.**

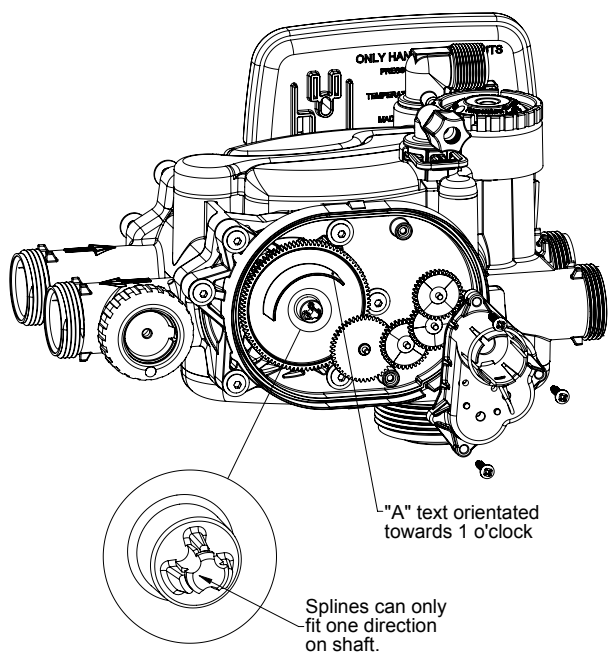

NOTICE

Be careful and make sure the meter cable doesn't get under the drive cap while tightening as it will result in damaging the cable.

2. Position the large white drive gear with the "A" pointing toward the 1 o'clock position and then press it onto the stainless steel drive shaft, make sure it snaps & locks into position.

NOTICE

The white drive gear is splined to the drive shaft and will only assemble in one orientation. Because of this it is not necessary that the discs and gear be exactly positioned, the positioning needs to be approximate but they have to fit on the shaft.

3. Next install the larger black reducing gear onto the stainless steel shaft, then install the remaining smaller reducing gears from left to right. Re-install the grey reducing gear cover over the gears and affix with the 3 stainless steel screws. Now you can re-install the drive motor by pressing the spring clip loop to the right then rotate the motor as you are inserting it so the gear of the motor meshes properly with the reducing gears. Release the spring clip loop and rotate the motor until the motor housing engages with the plastic nub inside the housing that holds the motor in place and make sure that the top of the motor is flush with the top of the grey gear housing. Press the drive motor wires down into the strain relief of the drive cap, now you can re-install the cover assembly.

After completing any valve maintenance involving the valve drive assembly or the transfer drive assembly please press and hold the NEXT & the REGEN buttons simultaneously for 3 to 5 seconds to perform a soft reset which will synchronize the control valves positions.

Troubleshooting

Problem	Possible Cause	Solution
1. No Display on PC Board	a. No power at electric outlet	a. Repair outlet or use working outlet
	b. Control valve Power Adapter not plugged into outlet or power cord end not connected to PC board connection	b. Plug Power Adapter into outlet or connect power cord end to PC Board connection
	c. Improper power supply	c. Verify proper voltage is being delivered to PC Board
	d. Defective Power Adapter	d. Replace Power Adapter
	e. Defective PC Board	e. Replace PC Board
2. PC Board does not display correct time of day	a. Power Adapter plugged into electric outlet controlled by light switch	a. Use uninterrupted outlet
	b. Tripped breaker switch and/or tripped GFI	b. Reset breaker switch and/ or GFI switch
	c. Power outage	c. Reset time of day. If PC Board has battery back up present the battery may be depleted. See Front Cover and Drive Assembly drawing for instructions.
	d. Defective PC Board	d. Replace PC Board
	a. Meter is not connected to meter connection on PC Board	a. Connect meter to three pin connection labeled METER on PC Board
	b. Restricted/ stalled meter turbine	c. Remove meter and check for rotation or foreign material
	c. Meter wire not installed securely into three pin connector	c. Verify meter cable wires are installed securely into three pin connector labeled METER
	d. Defective meter	d. Replace meter
	e. Defective PC Board	e. Replace PC Board
4. Control valve regenerates at wrong time of day	a. Power outage	a. Reset time of day. If PC Board has battery back up present the battery may be depleted. See Front Cover and Drive Assembly drawing for instructions.
	b. Time of day not set correctly	b. Reset to correct time of day
	c. Time of regeneration set incorrectly	c. Reset regeneration time
	d. Control valve set at "on 0" (immediate regeneration)	d. Check programming setting and reset to NORMAL (for a delayed regen time)
	e. Control valve set at "NORMAL + on 0" (delayed and/ or immediate)	e. Check programming setting and reset to NORMAL (for a delayed regen time)
5. Time of day flashes on and off	a. Power outage	a. Reset time of day. If PC Board has battery back up present the battery may be depleted. See Front Cover and Drive Assembly drawing for instructions.
6. Control valve does not regenerate automatically when the REGEN button is depressed and held.	a. Broken drive gear or drive cap assembly	a. Replace drive gear or drive cap assembly
	b. Broken Piston Rod	b. Replace piston rod
	c. Defective PC Board	c. Defective PC Board
7. Control valve does not regenerate automatically but does when the REGEN button is depressed and held.	a. Meter is not connected to meter connection on PC Board	a. Connect meter to three pin connection labeled METER on PC Board
	b. Restricted/ stalled meter turbine	b. Remove meter and check for rotation or foreign material
	c. Incorrect programming	c. Check for programming error
	d. Meter wire not installed securely into three pin connector	d. Verify meter cable wires are installed securely into three pin connector labeled METER
	e. Defective meter	e. Replace meter
	f. Defective PC Board	f. Replace PC Board

Problem	Possible Cause	Solution
8. Hard or untreated water is being delivered	a. Media is exhausted due to high water usage	a. Check program settings or diagnostics for abnormal water usage
	b. Meter not registering	b. Remove meter and check for rotation or foreign material
	c. Water quality fluctuation	c. Test water and adjust program values accordingly
	d. No regenerant or low level of regenerant in regenerant tank	d. Add proper regenerant to tank
	e. Control fails to draw in regenerant	e. Refer to Trouble Shooting Guide number 12
	f. Insufficient regenerant level in regenerant tank	f. Check refill setting in programming. Check refill flow control for restrictions or debris and clean or replace
	g. Damaged seal/stack assembly	g. Replace seal/stack assembly
	h. Control valve body type and piston type mix matched	h. Verify proper control valve body type and piston type match
	i. Fouled media bed	i. Replace media bed
9. Control valve uses too much regenerant	a. Improper refill setting	a. Check refill setting
	b. Improper program settings	b. Check program setting to make sure they are specific to the water quality and application needs
	c. Control valve regenerates frequently	c. Check for leaking fixtures that may be exhausting capacity or system is undersized
10. Residual regenerant being delivered to service	a. Low water pressure	a. Check incoming water pressure – water pressure must remain at minimum of 25 psi
	b. Incorrect injector size	b. Replace injector with correct size for the application
	c. Restricted drain line	c. Check drain line for restrictions or debris and clean
11. Excessive water in regenerant tank	a. Improper program settings	a. Check refill setting
	b. Plugged injector	b. Remove injector and clean or replace
	c. Drive cap assembly not tightened in properly	c. Re-tighten the drive cap assembly
	d. Damaged seal/ stack assembly	d. Replace seal/ stack
	e. Restricted or kinked drain line	e. Check drain line for restrictions or debris and or straighten drain line
	f. Plugged backwash flow controller	f. Remove backwash flow controller and clean or replace
	g. Missing refill flow controller	g. Replace refill flow controller
12. Control valve fails to draw in regenerant	a. Injector is plugged	a. Remove injector and clean or replace
	b. Faulty regenerant piston	b. Replace regenerant piston
	c. Regenerant line connection leak	c. Inspect regenerant line for air leak
	d. Drain line restriction or debris cause excess back pressure	d. Inspect drain line and clean to correct restriction
	e. Drain line too long or too high	e. Shorten length and or height
	f. Low water pressure	f. Check incoming water pressure – water pressure must remain at minimum of 25 psi
13. Water running to drain	a. Power outage during regeneration	a. Upon power being restored control will finish the remaining regeneration time. Reset time of day.
	b. Damaged seal/ stack assembly	b. Replace seal/ stack assembly
	c. Piston assembly failure	c. Replace piston assembly
	d. Drive cap assembly not tightened in properly	d. Re-tighten the drive cap assembly

Problem	Possible Cause	Solution
14. E1, Err – 1001, Err – 101 = Control unable to sense motor movement	a. Motor not inserted full to engage pinion, motor wires broken or disconnected	a. Disconnect power, make sure motor is fully engaged, check for broken wires, make sure two pin connector on motor is connected to the two pin connection on the PC Board labeled MOTOR. Press NEXT and REGEN buttons for 3 seconds to resynchronize software with piston position or disconnect power supply from PC Board for 5 seconds and then reconnect.
	b. PC Board not properly snapped into drive bracket	b. Properly snap PC Board into drive bracket and then Press NEXT and REGEN buttons for 3 seconds to resynchronize software with piston position or disconnect power supply from PC Board for 5 seconds and then reconnect.
	c. Missing reduction gears	c. Replace missing gears
15. E2, Err – 1002, Err – 102 = Control valve motor ran too short and was unable to find the next cycle position and stalled	a. Foreign material is lodged in control valve	a. Open up control valve and pull out piston assembly and seal/ stack assembly for inspection. Press NEXT and REGEN buttons for 3 seconds to resynchronize software with piston position or disconnect power supply from PC Board for 5 seconds and then reconnect.
	b. Mechanical binding	b. Check piston and seal/ stack assembly, check reduction gears, check drive bracket and main drive gear interface. Press NEXT and REGEN buttons for 3 seconds to resynchronize software with piston position or disconnect power supply from PC Board for 5 seconds and then reconnect.
	c. Main drive gear too tight	c. Loosen main drive gear. Press NEXT and REGEN buttons for 3 seconds to resynchronize software with piston position or disconnect power supply from PC Board for 5 seconds and then reconnect.
	d. Improper voltage being delivered to PC Board	d. Verify that proper voltage is being supplied. Press NEXT and REGEN buttons for 3 seconds to resynchronize software with piston position or disconnect power supply from PC Board for 5 seconds and then reconnect.
16. E3, Err – 1003, Err – 103 = Control valve motor ran too long and was unable to find the next cycle position	a. Motor failure during a regeneration	a. Check motor connections then Press NEXT and REGEN buttons for 3 seconds to resynchronize software with piston position or disconnect power supply from PC Board for 5 seconds and then reconnect.
	b. Foreign matter built up on piston and stack assemblies creating friction and drag enough to time out motor	b. Replace piston and stack assemblies. Press NEXT and REGEN buttons for 3 seconds to resynchronize software with piston position or disconnect power supply from PC Board for 5 seconds and then reconnect.
	c. Drive bracket not snapped in properly and out enough that reduction gears and drive gear do not interface	c. Snap drive bracket in properly then Press NEXT and REGEN buttons for 3 seconds to resynchronize software with piston position or disconnect power supply from PC Board for 5 seconds and then reconnect.

Problem	Possible Cause	Solution
<p>17. Err – 1004, Err – 104 = Control valve motor ran too long and timed out trying to reach home position</p>	<p>a. Drive bracket not snapped in properly and out enough that reduction gears and drive gear do not interface</p>	<p>a. Snap drive bracket in properly then Press NEXT and REGEN buttons for 3 seconds to resynchronize software with piston position or disconnect power supply from PC Board for 5 seconds and then reconnect.</p>
<p>18. Err -1006, Err – 106,</p> <p>Err - 116 = MAV/ SEPS/ NHBP/ AUX MAV valve motor ran too long and unable to find the proper park position</p> <p>Motorized Alternating Valve = MAV</p> <p>Separate Source = SEPS</p> <p>No Hard Water Bypass = NHBP</p> <p>Auxiliary MAV = AUX MAV</p>	<p>a. Control valve programmed for ALT A or b, nHbP, SEPS, or AUX MAV with out having a MAV or NHBP valve attached to operate that function</p>	<p>a. Press NEXT and REGEN buttons for 3 seconds to resynchronize software with piston position or disconnect power supply from PC Board for 5 seconds and then reconnect. Then re-program valve to proper setting</p>
	<p>b. MAV/ NHBP motor wire not connected to PC Board</p>	<p>b. Connect MAV/ NHBP motor to PC Board two pin connection labeled DRIVE. Press NEXT and REGEN buttons for 3 seconds to resynchronize software with piston position or disconnect power supply from PC Board for 5 seconds and then reconnect.</p>
	<p>c. MAV/ NHBP motor not fully engaged with reduction gears</p>	<p>c. Properly insert motor into casing, do not force into casing Press NEXT and REGEN buttons for 3 seconds to resynchronize software with piston position or disconnect power supply from PC Board for 5 seconds and then reconnect.</p>
	<p>d. Foreign matter built up on piston and stack assemblies creating friction and drag enough to time out motor</p>	<p>d. Replace piston and stack assemblies. Press NEXT and REGEN buttons for 3 seconds to resynchronize software with piston position or disconnect power supply from PC Board for 5 seconds and then reconnect.</p>
<p>19. Err – 1007, Err – 107,</p> <p>Err - 117 = MAV/ SEPS/ NHBP/ AUX MAV valve motor ran too short (stalled) while looking for proper park position</p> <p>Motorized Alternating Valve = MAV</p> <p>Separate Source = SEPS</p> <p>No Hard Water Bypass = NHBP</p> <p>Auxiliary MAV = AUX MAV</p>	<p>a. Foreign material is lodged in MAV/ NHBP valve</p>	<p>a. Open up MAV/ NHBP valve and check piston and seal/ stack assembly for foreign material. Press NEXT and REGEN buttons for 3 seconds to resynchronize software with piston position or disconnect power supply from PC Board for 5 seconds and then reconnect.</p>
	<p>b. Mechanical binding</p>	<p>b. Check piston and seal/ stack assembly, check reduction gears, drive gear interface, and check MAV/ NHBP black drive pinion on motor for being jammed into motor body. Press NEXT and REGEN buttons for 3 seconds to resynchronize software with piston position or disconnect power supply from PC Board for 5 seconds and then reconnect.</p>

NOTES

WARNING: This product contains chemicals known to the State of California to cause cancer and birth defects or other reproductive harm.
For more information: www.watts.com/prop65

LIMITED WARRANTY: Certain Watts products come with a limited warranty from Watts Regulator Co. Other products may have no warranty or are covered by the original manufacturer's warranty only. For specific product warranty information, please visit www.watts.com or the published literature that comes with your product. Any remedies stated in such warranties are exclusive and are the only remedies for breach of warranty. **EXCEPT FOR THE APPLICABLE PRODUCT WARRANTY, IF ANY, WATTS MAKES NO OTHER WARRANTIES, EXPRESS OR IMPLIED. TO THE FULLEST EXTENT PERMITTED BY APPLICABLE LAW, WATTS HEREBY SPECIFICALLY DISCLAIMS ALL OTHER WARRANTIES, EXPRESS OR IMPLIED, INCLUDING BUT NOT LIMITED TO THE IMPLIED WARRANTIES OF MERCHANTABILITY AND FITNESS FOR A PARTICULAR PURPOSE, AND IN NO EVENT SHALL WATTS BE LIABLE, IN CONTRACT, TORT, STRICT LIABILITY OR UNDER ANY OTHER LEGAL THEORY, FOR INCIDENTAL, INDIRECT, SPECIAL OR CONSEQUENTIAL DAMAGES, INCLUDING, WITHOUT LIMITATION, LOST PROFITS OR PROPERTY DAMAGE, REGARDLESS OF WHETHER IT WAS INFORMED ABOUT THE POSSIBILITY OF SUCH DAMAGES.**



A Watts Water Technologies Company

USA: Tel: (800) 659-8400 • Fax: (800) 659-8402 • Watts.com

Canada: Tel: (905) 332-4090 • Fax: (905) 332-7068 • Watts.ca

Latin America: Tel: (52) 81-1001-8600 • Fax: (52) 81-8000-7091 • Watts.com